



COLOUR CHORUS 24™

user manual

©2015 **ELATION PROFESSIONAL** all rights reserved. Information, specifications, diagrams, images, and instructions herein are subject to change without notice. ELATION PROFESSIONAL logo and identifying product names and numbers herein are trademarks of ELATION PROFESSIONAL. Copyright protection claimed includes all forms and matters of copyrightable materials and information now allowed by statutory or judicial law or hereinafter granted. Product names used in this document may be trademarks or registered trademarks of their respective companies and are hereby acknowledged. All non-ELATION brands and product names are trademarks or registered trademarks of their respective companies.

ELATION PROFESSIONAL and all affiliated companies hereby disclaim any and all liabilities for property, equipment, building, and electrical damages, injuries to any persons, and direct or indirect economic loss associated with the use or reliance of any information contained within this document, and/or as a result of the improper, unsafe, insufficient and negligent assembly, installation, rigging, and operation of this product.

Elation Professional USA | 6122 S. Eastern Ave. | Los Angeles, CA. 90040
323-582-3322 | 323-832-9142 fax | www.elationlighting.com | info@elationlighting.com

Elation Professional B.V. | Junostraat 2 | 6468 EW Kerkrade, The Netherlands
+31 45 546 85 66 | +31 45 546 85 96 fax | www.elationlighting.eu | info@elationlighting.eu

DOCUMENT VERSION



Please check www.elationlighting.com for the latest revision/update of this manual.

Date	Document Version	Software Version	DMX Channel Modes	Notes
9/20/15	1	≥1.10	3 / 4 / 5 / 6 / 9 / 10 / 11 / 12 / 14 / 16 / 17 / 19 / 21	Updated Format.

C O N T E N T S

General Information	4
Warranty	6
Safety Instructions	7
General Guidelines	8
Fixture Overview	9
Fixture Installation	10
Fixture Menu	12
DMX Channel Functions And Values	15
Cleaning and Maintenance	23
Technical Specifications	24
Optional Accessories	27

GENERAL INFORMATION

INTRODUCTION

Congratulations, you have just purchased one of the most innovative and reliable lighting fixtures on the market today! The fixture has been designed to perform reliably for years when the guidelines in this booklet are followed. Please read and understand the instructions in this manual carefully and thoroughly before attempting to operate this unit. These instructions contain important information regarding safety during use and maintenance.

UNPACKING

Every fixture has been thoroughly tested and has been shipped in perfect operating condition. Carefully check the shipping carton for damage that may have occurred during shipping. If the carton appears to be damaged, carefully inspect your unit for damage and be sure all accessories necessary to operate the unit have arrived intact. In the event damage has been found or parts are missing, please contact our customer support team for further instructions. Please do not return this unit to your dealer without first contacting customer support at the number listed below. Please do not discard the shipping carton in the trash. Please recycle whenever possible.

BOX CONTENTS

- (1) powerCON Cable
- Manual & Warranty Card

CUSTOMER SUPPORT

Elation Professional® provides a customer support line, to provide set up help and to answer any question should you encounter problems during your set up or initial operation. You may also visit us on the web at www.elationlighting.com for any comments or suggestions. For service related issue please contact Elation Professional®.

ELATION SERVICE USA - Monday - Friday 8:00am to 5:00pm PST

Voice: 323-582-3322

Fax: 323-832-9142

E-mail: support@elationlighting.com

ELATION SERVICE EUROPE - Monday - Friday 08:30 to 17:00 CET

Voice: +31 45 546 85 30

Fax: +31 45 546 85 96

E-mail: support@elationlighting.eu

WARRANTY REGISTRATION

Please complete and mail in the enclosed warranty card or register online: <http://www.elationlighting.com/Login.aspx> to validate your purchase. All returned service items whether under warranty or not, must be freight pre-paid and accompany a return authorization (R.A.) number. The R.A. number must be clearly written on the outside of the return package. A brief description of the problem as well as the R.A. number must also be written down on a piece of paper and included in the shipping container. If the unit is under warranty, you must provide a copy of your proof of purchase invoice. Items returned without a R.A. number clearly marked on the outside of the package will be refused and returned at customer's expense. You may obtain a R.A. number by contacting customer support.



IMPORTANT NOTICE!

There are no user serviceable parts inside this unit. Do not attempt any repairs yourself; doing so will void your manufactures warranty. Damages resulting from modifications to this fixture and/or the disregard of safety and general user instructions found in this user manual void the manufactures warranty and are not subject to any warranty claims and/or repairs.

LIMITED WARRANTY

A. Elation Professional® hereby warrants, to the original purchaser, Elation Professional® products to be free of manufacturing defects in material and workmanship for a period of two years (730 days), and Elation Professional® product rechargeable batteries to be free of manufacturing defects in material and workmanship for a period of six months (180 days), from the original date of purchase. This warranty excludes discharge lamps and all product accessories. This warranty shall be valid only if the product is purchased within the United States of America, including possessions and territories. It is the owner's responsibility to establish the date and place of purchase by acceptable evidence, at the time service is sought.

B. For warranty service, send the product only to the Elation Professional® factory. All shipping charges must be pre-paid. If the requested repairs or service (including parts replacement) are within the terms of this warranty, Elation Professional® will pay return shipping charges only to a designated point within the United States. If any product is sent, it must be shipped in its original package and packaging material. No accessories should be shipped with the product. If any accessories are shipped with the product, Elation Professional® shall have no liability what so ever for loss and/or or damage to any such accessories, nor for the safe return thereof.

C. This warranty is void if the product serial number and/or labels are altered or removed; if the product is modified in any manner which Elation Professional® concludes, after inspection, affects the reliability of the product; if the product has been repaired or serviced by anyone other than the Elation Professional® factory unless prior written authorization was issued to purchaser by Elation Professional®; if the product is damaged because not properly maintained as set forth in the product instructions, guidelines and/or user manual.

D. This is not a service contract, and this warranty does not include any maintenance, cleaning or periodic check-up. During the periods as specified above, Elation Professional® will replace defective parts at its expense, and will absorb all expenses for warranty service and repair labor by reason of defects in material or workmanship. The sole responsibility of Elation Professional® under this warranty shall be limited to the repair of the product, or replacement thereof, including parts, at the sole discretion of Elation Professional®. All products covered by this warranty were manufactured after January 1, 1990, and bare identifying marks to that effect.

E. Elation Professional® reserves the right to make changes in design and/or performance improvements upon its products without any obligation to include these changes in any products theretofore manufactured.

F. No warranty, whether expressed or implied, is given or made with respect to any accessory supplied with the products described above. Except to the extent prohibited by applicable law, all implied warranties made by Elation Professional® in connection with this product, including warranties of merchantability or fitness, are limited in duration to the warranty periods set forth above. And no warranties, whether expressed or implied, including warranties of merchantability or fitness, shall apply to this product after said periods have expired. The consumer's and/or dealer's sole remedy shall be such repair or replacement as is expressly provided above; and under no circumstances shall Elation Professional® be liable for any loss and/or damage, direct and/or consequential, arising out of the use of, and/or the inability to use, this product.

G. This warranty is the only written warranty applicable to Elation Professional® products and supersedes all prior warranties and written descriptions of warranty terms and conditions heretofore published.

SAFETY INSTRUCTIONS



This fixture is an extremely sophisticated piece of electronic equipment. To guarantee a smooth operation, it is important to follow the guidelines in this manual. The manufacturer of this device will not accept responsibility for damages resulting from the misuse of this fixture due to the disregard of the information printed in this manual.



This device falls under **PROTECTION CLASS 1**. It's essential this device be grounded properly. Only qualified personnel should perform all electrical connections.



I N D O O R S U S E O N L Y !
DO NOT EXPOSE FIXTURE RAIN AND MOISTURE!



UNPLUG POWER BEFORE SERVICING FIXTURE!
DO NOT PLUG FIXTURE INTO A DIMMER PACK!
NEVER TOUCH FIXTURE DURING OPERATION, AS IT MAY BE HOT!



NEVER LOOK DIRECTLY INTO THE LIGHT SOURCE!
SENSITIVE PERSONS MAY SUFFER AN EPILEPTIC SHOCK!

- For proper operation, follow the **Installation** guidelines described in this manual. Only qualified and certified personnel should perform installation of this fixture and only the original rigging parts (brackets) included with this fixture should be used for installation. Any modifications will void the original manufacturer's warranty and increase the risk of damage and/or personal injury.
- Never look directly into the light source of this fixture to prevent risk of injury to your retina, which may induce blindness. Those suffering from **EPILEPSY** should avoid looking directly into the light source of this unit at all times.
- The fan and air inlets must remain clean and never blocked. Allow approx. 6" (15cm) between this fixture and other devices or a wall for proper cooling.
- Always disconnect from main power source before performing any type of service and/or cleaning procedure. Only handle the power cord by the plug end, never pull out the plug by tugging the wire portion of the cord.
- Do not operate this fixture if the power cord has become frayed, crimped and/or damaged. If the power cord is damaged, replace it immediately with a new one of similar power rating.

GENERAL GUIDELINES

- **NEVER OPEN THIS FIXTURE WHILE IN USE!**
- During the initial operation of this fixture, a light smoke or smell may emit from the interior of the fixture. This is a normal process and is caused by excess paint in the interior of the casing burning off from the heat associated with the lamp and will decrease gradually over time.
- This fixture is a professional lighting effect designed for **INDOOR / DRY LOCATIONS ONLY** on stage, in nightclubs, theatres, etc.
- Please make sure there are **NO FLAMMABLE MATERIALS** close to the fixture while operating, to prevent any fire hazard.
- The fixture must be installed in a location with adequate ventilation, at least 1.5 feet (.5m) from adjacent surfaces. Be sure no air ventilation slots are blocked.
- **DO NOT** attempt installation and/or operation without knowledge how to do so.
- **DO NOT** permit operation by persons who are not qualified to operate this type of fixture. Most damages are the result of operations by nonprofessionals.
- Consistent operational breaks may ensure the fixture will function properly for many years to come.
- **DO NOT** shake fixture, avoid brute force when installing and/or operating fixture.
- Always install the fixture with an appropriate safety cable. When installing the fixture in a suspended environment, always use mounting hardware that is no less than M10 x 25 mm, also be sure the hardware is insert in the pre-arranged screw holes in the bracket of the fixture.
- Use the original packaging and materials to transport the fixture in for service.
- **DO NOT TOUCH** the housing bare-hand during its operation. Turn OFF the power and allow approximately 15 minutes for the fixture to cool down before replacing or serving.

FIXTURE OVERVIEW

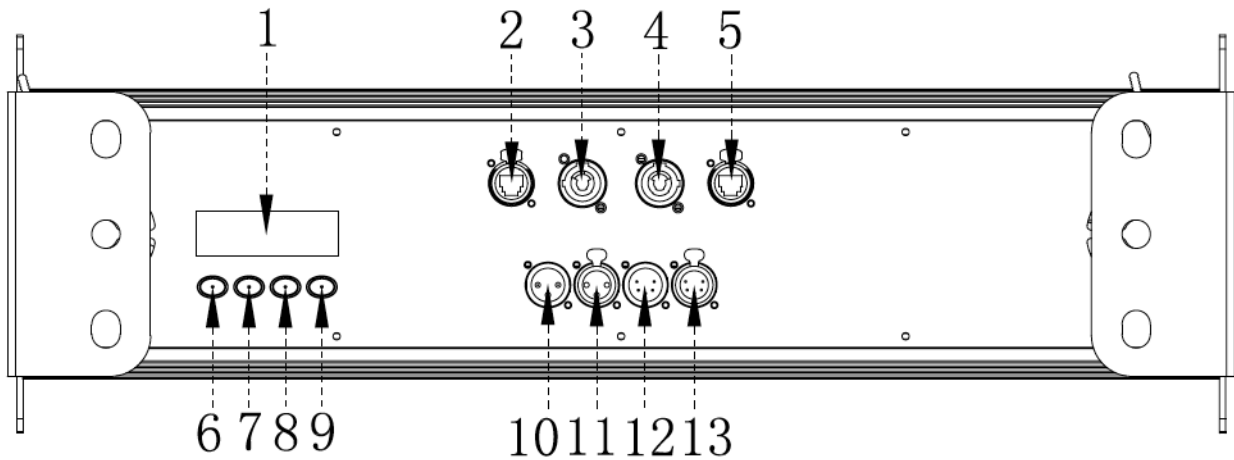

1. LCD Menu Control Display
2. RJ45 NET IN
3. powerCON IN
4. powerCON OUT
5. RJ45 NET OUT
6. MODE Button
7. UP Button
8. DOWN Button
9. ENTER Button
10. 3pin DMX IN
11. 3pin DMX OUT
12. 5pin DMX IN
13. 5pin DMX OUT

FIXTURE INSTALLATION



FLAMMABLE MATERIAL WARNING

Keep fixture at least 5.0 ft. (1.5m) away from any flammable materials, decorations, pyrotechnics, etc.



ELECTRICAL CONNECTIONS

A qualified electrician should be used for all electrical connections and/or installations.



CAUTIONS

- For added protection, mount the fixture in areas outside walking paths, seating areas, or in areas where unauthorized personnel might reach the fixture.
- Ambient operating temperature range for this fixture is **5°F to 113°F (-15°C to 45°C)**. Do not use the fixture under or above this temperature.
- Before mounting the fixture to any surface, make sure the installation area can hold a minimum point load of 10 times the weight of the fixture.
- Fixture installation must always be secured with a secondary safety attachment, such as an appropriate safety cable.
- Never stand directly below the device when mounting, removing or servicing.



POWER LINKING

Max number of units that can be power linked is **4 units @110V** and **10 units @240V**.

CLAMP MOUNTING

The fixture provides integrated and adjustable rigging brackets. When mounting this fixture to truss be sure to secure an appropriately rated clamps to the rigging brackets using a M10 screw fitted through the center hole.

MOUNTING POINTS

- Overhead mounting requires extensive experience, including amongst others calculating working load limits, installation material being used, and periodic safety inspection of all installation material and the device. If you lack these qualifications, do not attempt the installation yourself. Improper installation can result in bodily injury.
- Fixture is fully operational in the specific mounting positions as illustrated below.

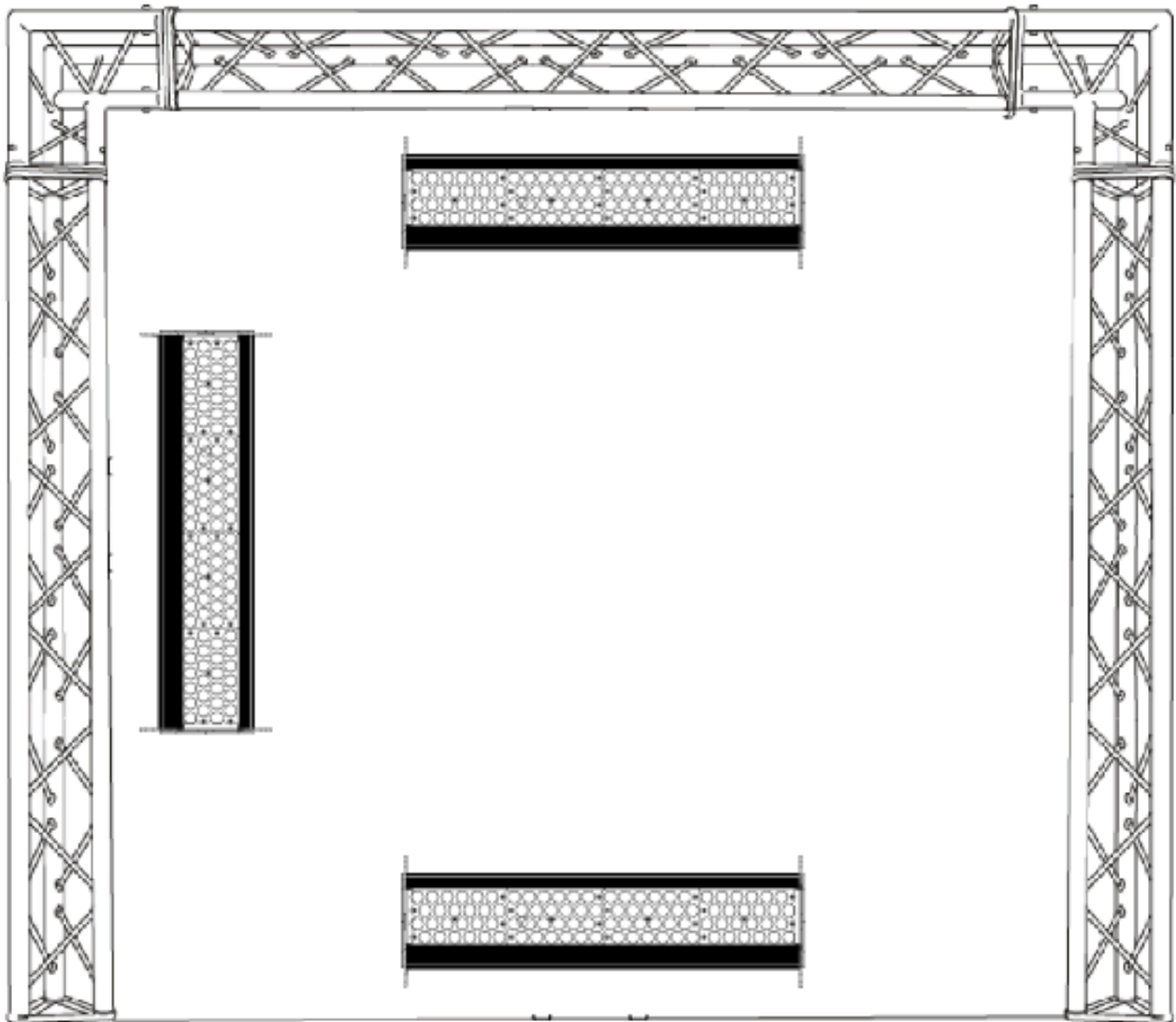

SAFETY CABLE

Always use a Safety Cable whenever installing this fixture in a suspended environment to ensure the fixture will not drop if the clamp fails.

FIXTURE MENU

ON-BOARD SYSTEM MENU

The fixture comes with an easy to navigate system menu. The next section will detail the functions of each command in the system menu.

LCD MENU CONTROL PANEL

The control panel (see image below) located on the back of the fixture allows you to access the main menu and make all necessary adjustments to the fixture. During normal operation, pressing **MODE** button once will access the fixture's main menu. Once in the main menu you can navigate through the different functions and access the sub-menus with the **UP**, and **DOWN** buttons. Once you reach a field that requires adjusting, press the **ENTER** button to activate that field and use the **UP** and **DOWN** buttons to adjust the field. Pressing the **ENTER** button once more will confirm your setting. You may exit the main menu at any time without making any adjustments by pressing the **MODE** button.

 **NOTE:** the LCD Menu Control Display will shut OFF and lockout after 30 seconds of no use. Press and hold the **MODE** button for 10 seconds to unlock the LCD display.



INFORMATION DISPLAYED DURING INITIAL POWER ON

When the fixture is initially powered ON, the display shows the following information:



**ELATION® COLOUR CHORUS 24™
SYSTEM MENU**

Specifications are subject to change without any prior written notice.
Default Settings in **BOLD**.

MENU	OPTIONS / VALUES			DESCRIPTION
Set Address	ADDR:001 - XXX			Set DMX Address.
User Mode	➔ Refer to the DMX CHANNEL MODE TABLE on page 15			Set User Mode.
Effect	Programs	1-12	Program Speed 0-255 Program Fade 0-255	
	Macros	0-255 (64 Total Color Macros)		See DMX Traits for Values.
	Manual R	0-255		
	Manual G Manual B Manual A	0-255 0-255 0-255		
Function	Status	Remote DMX Addr: ON / OFF No DMX Mode: Blackout / Hold / Program		
	Fixture ID	Service PIN RDM PID Device IP Addr Ctrl IP Addr Universe	Password = 050 XXXXXX XXX.XXX.XXX.XXX XXX.XXX.XXX.XXX XXX	
	Protocol Set	Kling-Net, ArtNet		
	Net Switch	ON / OFF		
	Fan Set	LED Fan	Auto High Low	
	LCD. Set	Display Key Lock DispFlash	ON / OFF ON / OFF ON / OFF	
	Temp. C/F	Celsius Fahrenheit		
	Dim. Curve	Standard, Stage, TV, Architectural, Theatre		Set desired Dimming Curve.
	Pixel Flip	Standard / Flip		Set starting LED Group. See Pixel Flip Section.
	Intensity Mode	Standard / High Output		
Reset to Default	OFF / ON			
Information	Time. Info	Current		
		Total Time		
		Last Clear		
		Timer PIN		
		Clear Last		
	Temp. Info	LED Temp.		
	Model. Info	Colour Chorus 24		
Software.V	≥1.10			

DIMMING CURVES

The **DimCurve** menu allows you to select one of the following preset dimming curves: **Standard, Stage, TV, Architectural, Theatre, or Default.**

(See diagram below for more details)

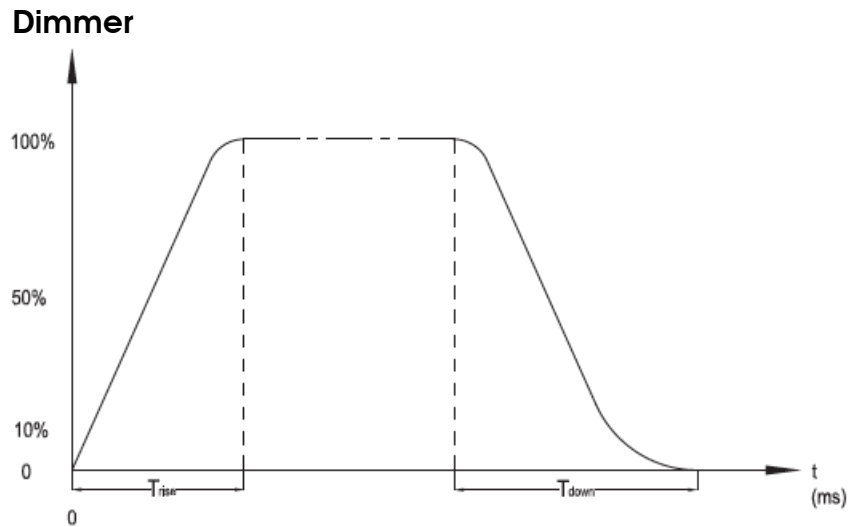

Ramp Effect	OS (Fade Time)		1S (Fade Time)	
	T_{rise} (ms)	T_{down} (ms)	T_{rise} (ms)	T_{down} (ms)
Standard	0	0	0	0
Stage	780	1100	1540	1660
TV	1180	1520	1860	1940
Architectural	1380	1730	2040	2120
Theatre	1580	1940	2230	2280

PIXEL FLIP

Select the desired starting LED Group direction from one of the following modes below via **UP/DOWN** buttons and then press **ENTER** to confirm.

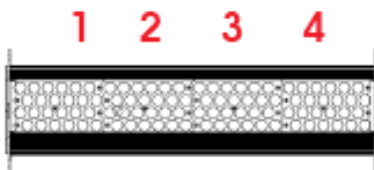

STANDARD

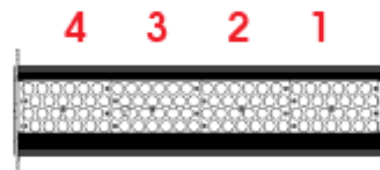

FLIP

DMX CHANNEL FUNCTIONS AND VALUES

Please refer to the table below to find the corresponding **MOD #** for each **DMX Channel Mode** listed in the following DMX traits.

DMX CHANNEL MODE TABLE

MOD #	01	02	03	04	05	06	07	08	09
DMX CH MODE	HSI 3CH	DA 3CH	HSI+ 4CH	RGBA 4CH	DA+ 5CH	sRGBI 5CH	RGBA+ 6CH	sRGBI 9 CH	fxHSI 9CH

MOD #	10	11	12	13	14	15	16	17	18	19
DMX CH MODE	sRGBI+ 10CH	fxHSI+ 11CH	DA 12CH	HSI 12CH	DA+ 14CH	fxHSI 19CH	fxHSI+ 21CH	RGBA 16CH	sRGBI 17CH	sRGBI+ 21CH

ELATION® COLOUR CHORUS 24™

DMX Channel Values / Functions Version 1 (21 DMX Channels)

Specifications are subject to change without any prior written notice.

*Control of LED Modules depends on the Pixel Flip setting.

MODE / CHANNEL																			VALUE	FUNCTION
01	02	03	04	05	06	07	08	09	10	11	12	13	14	15	16	17	18	19		
																				LED GROUP 1-4*
																			0-1	GROUP 1
																			2-5	GROUP 2
																			6-7	GROUP 3
																			8-9	GROUP 4
																			10-115	NO Function
																			116	Between GROUP 1
														1	1				117-120	Between GROUP 2
																			121-122	Between GROUP 3
																			123-124	Between GROUP 4
																			125-207	NO Function
																			208-211	Interval GROUP 1
																			212-213	Interval GROUP 2
																			214-215	Interval GROUP 3
																			216-217	Interval GROUP 4
																			218-255	NO Function
								1		1					2	2				COLOR SPEED
																			0-255	Color Speed SLOW TO FAST
								2		2					3	3				COLOR FAN
																			0-255	Variable Color Fan MIN to MAX
								3		3					4	4				COLOR RANGE
																			0-255	Adjust Color Spectrum
								4		4					5	5				COLOR STEP
																			0-254	Step to Fade Color Scroll Control
																			255	Switch to RGB
																				STROBE
																			0-31	NO Function
																			32-95	Variable Strobe Effect SLOW to FAST
					1		1	5	1	5					6	6	1	1	96-127	LEDs ON
																			128-159	Pulse Effect In Sequence SLOW to FAST
																			160-191	LEDs ON
																			192-223	Random Strobe Effect SLOW to FAST
																			224-255	LEDs ON

ELATION® COLOUR CHORUS 24™

DMX Channel Values / Functions Version 1 (21 DMX Channels)

Specifications are subject to change without any prior written notice.

*Control of LED Modules depends on the Pixel Flip setting.

MODE / CHANNEL																			VALUE	FUNCTION
01	02	03	04	05	06	07	08	09	10	11	12	13	14	15	16	17	18	19		
								6		6				7	7					FAN INTENSITY
																			0-255	Alternating Groups ON / OFF
1		1						7		7										HUE
																			0-255	0 to 100%
2		2						8		8										SATURATION
																			0-255	0 to 100%
3		3						9		9										INTENSITY
																			0-255	0 to 100%
	1		1	1	2	1	2		2											RED
																			0-255	0 to 100%
	2		2	2	3	2	3		3											GREEN
																			0-255	0 to 100%
	3		3	3	4	3	4		4											BLUE
																			0-255	0 to 100%
			4			4														AMBER
																			0-255	0 to 100%
				4	5	5	5		5	10										MASTER DIMMER
																			0-255	Intensity 0 to 100%
																				PROGRAMS
																			0-19	NO FUNCTION
																			20-39	Program 1
																			40-59	Program 2
																			60-79	Program 3
																			80-99	Program 4
																			100-119	Program 5
								6		6									120-139	Program 6
																			140-159	Program 7
																			160-179	Program 8
																			180-199	Program 9
																			200-219	Program 10
																			220-239	Program 11
																			240-255	Program 12
								7		7										PROGRAM SPEED
																			0-255	Program Speed SLOW to FAST
								8		8										PROGRAM FADE
																			0-255	Program Fade SLOW to FAST

ELATION® COLOUR CHORUS 24™
DMX Channel Values / Functions Version 1 (21 DMX Channels)

Specifications are subject to change without any prior written notice.

**Control of LED Modules depends on the Pixel Flip setting.*

MODE / CHANNEL																			VALUE	FUNCTION
01	02	03	04	05	06	07	08	09	10	11	12	13	14	15	16	17	18	19		
																				COLOR MACROS
																			1-4	Color Macro 01
																			5-8	Color Macro 02
																			9-12	Color Macro 03
																			13-16	Color Macro 04
																			17-20	Color Macro 05
																			21-24	Color Macro 06
																			25-28	Color Macro 07
																			29-32	Color Macro 08
																			33-36	Color Macro 09
																			37-40	Color Macro 10
																			41-44	Color Macro 11
																			45-48	Color Macro 12
																			49-52	Color Macro 13
																			53-56	Color Macro 14
																			57-60	Color Macro 15
							9		9										61-64	Color Macro 16
																			65-68	Color Macro 17
																			69-72	Color Macro 18
																			73-76	Color Macro 19
																			77-80	Color Macro 20
																			81-84	Color Macro 21
																			85-88	Color Macro 22
																			89-92	Color Macro 23
																			93-96	Color Macro 24
																			97-100	Color Macro 25
																			101-104	Color Macro 26
																			105-108	Color Macro 27
																			109-112	Color Macro 28
																			113-116	Color Macro 29
																			117-120	Color Macro 30
																			121-124	Color Macro 31
																			125-128	Color Macro 32

ELATION® COLOUR CHORUS 24™

DMX Channel Values / Functions Version 1 (21 DMX Channels)

Specifications are subject to change without any prior written notice.

**Control of LED Modules depends on the Pixel Flip setting.*

MODE / CHANNEL																			VALUE	FUNCTION
01	02	03	04	05	06	07	08	09	10	11	12	13	14	15	16	17	18	19		
																			129-132	Color Macro 33
																			133-136	Color Macro 34
																			137-140	Color Macro 35
																			141-144	Color Macro 36
																			145-148	Color Macro 37
																			149-152	Color Macro 38
																			153-156	Color Macro 39
																			157-160	Color Macro 40
																			161-164	Color Macro 41
																			165-168	Color Macro 42
																			169-172	Color Macro 43
																			173-176	Color Macro 44
																			177-180	Color Macro 45
																			181-184	Color Macro 46
																			185-188	Color Macro 47
								9			9								189-192	Color Macro 48
																			193-196	Color Macro 49
																			197-200	Color Macro 50
																			201-204	Color Macro 51
																			205-208	Color Macro 52
																			209-212	Color Macro 53
																			213-216	Color Macro 54
																			217-220	Color Macro 55
																			221-224	Color Macro 56
																			225-228	Color Macro 57
																			229-232	Color Macro 58
																			233-236	Color Macro 59
																			237-240	Color Macro 60
																			241-244	Color Macro 61
																			245-248	Color Macro 62
																			249-252	Color Macro 63
																			253-255	Color Macro 64

ELATION® COLOUR CHORUS 24™

DMX Channel Values / Functions Version 1 (21 DMX Channels)

Specifications are subject to change without any prior written notice.

*Control of LED Modules depends on the Pixel Flip setting.

MODE / CHANNEL																			VALUE	FUNCTION
01	02	03	04	05	06	07	08	09	10	11	12	13	14	15	16	17	18	19		
											1		1			1	2	2	0-255	RED - LED GROUP 1*
																				0 to 100%
											2		2			2	3	3	0-255	GREEN - LED GROUP 1*
																				0 to 100%
											3		3			3	4	4	0-255	BLUE - LED GROUP 1*
																				0 to 100%
																4			0-255	AMBER - LED GROUP 1*
																				0 to 100%
																	5	5	0-255	INTENSITY - LED GROUP 1*
																				0 to 100%
											4		4			5	6	6	0-255	RED - LED GROUP 2*
																				0 to 100%
											5		5			6	7	7	0-255	GREEN - LED GROUP 2*
																				0 to 100%
											6		6			7	8	8	0-255	BLUE - LED GROUP 2*
																				0 to 100%
																8			0-255	AMBER - LED GROUP 2*
																				0 to 100%
																	9	9	0-255	INTENSITY - LED GROUP 2*
																				0 to 100%
											7		7			9	10	10	0-255	RED - LED GROUP 3*
																				0 to 100%
											8		8			10	11	11	0-255	GREEN - LED GROUP 3*
																				0 to 100%
											9		9			11	12	12	0-255	BLUE - LED GROUP 3*
																				0 to 100%
																12			0-255	AMBER - LED GROUP 3*
																				0 to 100%
																	13	13	0-255	INTENSITY - LED GROUP 3*
																				0 to 100%
											10		10			13	14	14	0-255	RED - LED GROUP 4*
																				0 to 100%
											11		11			14	15	15	0-255	GREEN - LED GROUP 4*
																				0 to 100%
											12		12			15	16	16	0-255	BLUE - LED GROUP 4*
																				0 to 100%
																16			0-255	AMBER - LED GROUP 4*
																				0 to 100%
																	17	17	0-255	INTENSITY - LED GROUP 4*
																				0 to 100%

ELATION® COLOUR CHORUS 24™

DMX Channel Values / Functions Version 1 (21 DMX Channels)

Specifications are subject to change without any prior written notice.

*Control of LED Modules depends on the Pixel Flip setting.

MODE / CHANNEL																			VALUE	FUNCTION
01	02	03	04	05	06	07	08	09	10	11	12	13	14	15	16	17	18	19		
																			18	PROGRAMS
																			0-19	NO FUNCTION
																			20-39	Program 1
																			40-59	Program 2
																			60-79	Program 3
																			80-99	Program 4
																			100-119	Program 5
																			120-139	Program 6
																			140-159	Program 7
																			160-179	Program 8
																			180-199	Program 9
																			200-219	Program 10
																			220-239	Program 11
																			240-255	Program 12
																			19	PROGRAM SPEED
																			0-255	Program Speed SLOW to FAST
												1		8	8					HUE - LED GROUP 1*
												0-255								0 to 100%
												2		9	9					SATURATION - LED GROUP 1*
												0-255								0 to 100%
												3		10	10					INTENSITY - LED GROUP 1*
												0-255								0 to 100%
												4		11	11					HUE - LED GROUP 2*
												0-255								0 to 100%
												5		12	12					SATURATION - LED GROUP 2*
												0-255								0 to 100%
												6		13	13					INTENSITY - LED GROUP 2*
												0-255								0 to 100%
												7		14	14					HUE - LED GROUP 3*
												0-255								0 to 100%
												8		15	15					SATURATION - LED GROUP 3*
												0-255								0 to 100%
												9		16	16					INTENSITY - LED GROUP 3*
												0-255								0 to 100%
												10		17	17					HUE - LED GROUP 4*
												0-255								0 to 100%
												11		18	18					SATURATION - LED GROUP 4*
												0-255								0 to 100%
												12		19	19					INTENSITY - LED GROUP 4*
												0-255								0 to 100%
												13		20				20		MASTER DIMMER
												0-255								Intensity 0 to 100%

ELATION® COLOUR CHORUS 24™
DMX Channel Values / Functions Version 1 (21 DMX Channels)

Specifications are subject to change without any prior written notice.

**Control of LED Modules depends on the Pixel Flip setting.*

MODE / CHANNEL																			VALUE	FUNCTION
01	02	03	04	05	06	07	08	09	10	11	12	13	14	15	16	17	18	19		
																				DIMMING CURVE MODES
																			0-20	STANDARD
																			21-40	STAGE
		4		5		6			10	11			14		21			21	41-60	TV
																			61-80	ARCHITECTURAL
																			81-100	THEATRE
																			101-255	Default to Unit Setting

CLEANING AND MAINTENANCE



C A U T I O N

Disconnect power before cleaning or maintenance.

CLEANING

Frequent cleaning is recommended to insure proper function, optimized light output, and an extended life. The frequency of cleaning depends on the environment in which the fixture operates: damp, smoky or particularly dirty environments can cause greater accumulation of dirt on the fixture's optics.

- Clean the external lens surface at least every 20 days with a soft cloth to avoid dirt/debris accumulation.
- Never use alcohol, solvents, or ammonia based cleaners.

MAINTENANCE

Regular inspections are recommended to insure proper function and extended life. There are no user serviceable parts inside this fixture, please refer all other service issues to an authorized Elation service technician. Should you need any spare parts, please order genuine parts from your local Elation dealer.

Please refer to the following points during routine inspections:

- A detailed electric check by an approved electrical engineer every three months, to make sure the circuit contacts are in good condition and prevent overheating.
- Be sure all screws and fasteners are securely tightened at all times. Loose screws may fall out during normal operation resulting in damage or injury as larger parts could fall.
- Check for any deformations on the housing, color lenses, rigging hardware and rigging points (ceiling, suspension, trussing). Deformations in the housing could allow for dust to enter into the fixture. Damaged rigging points or unsecured rigging could cause the fixture to fall and seriously injure a person(s).
- Electric power supply cables must not show any damage, material fatigue or sediments. Never remove the ground prong from the power cable.

TECHNICAL SPECIFICATIONS

SOURCE

Individual 3W (Red, Green, Blue, Amber) LEDs 24 of Each Color
100,000 Hour Average LED Life*

*LED Life may vary depending on several factors including but not limited to: Environmental Conditions, Power/Voltage, Usage Patterns (On-Off Cycling), Control, and Dimming.

EFFECTS

Strobe and Chase Effects / Variable Dimming Curves
Individual Hue, Saturation, Intensity Control

CONTROL / CONNECTIONS

Multiple DMX Channel Modes
4 Button Control Panel and LCD Menu Display
ArtNet™ / KlingNET™ / RDM Protocol Support
(2) RJ45 Ports, 3pin and 5pin DMX In/Out
powerCON Power In/Out
Power Link Up To (4) Units at 120V (10) Units at 230V

SIZE / WEIGHT

Length: 23.8" (604mm)
Width: 7.5" (194.1mm)
Vertical Height: 7.6" (192.5mm)
Weight: 23.0 lbs. (10.4kg)

ELECTRICAL / THERMAL

AC 110-250V - 50/60Hz
200W Max Power Consumption
5°F to 113°F (-15°C to 45°C)

APPROVALS / RATINGS

CE | IP30



Intertek
4010765

Please Note: Specifications and improvements in the design of this unit and this manual are subject to change without any prior written notice.

PHOTOMETRIC DATA

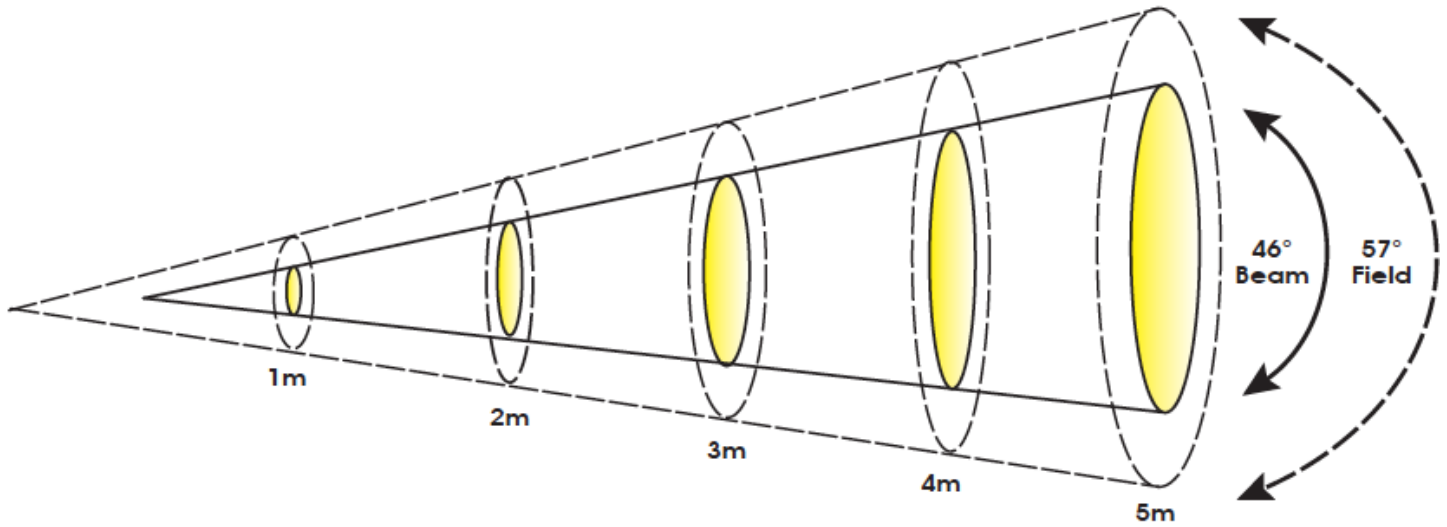

	m		ft		m		ft		m		ft		m		ft	
Distance	1	3.3	2	6.6	3	9.8	4	13.1	5	16.4						
46° Beam Diameter	0.85	2.8	1.7	5.6	2.55	8.4	3.4	11.2	4.24	13.9						
57° Field Diameter	1.09	3.6	2.71	8.9	3.28	10.8	4.34	14.2	5.43	17.8						
Photometrics	lux	fc	lux	fc	lux	fc	lux	fc	lux	fc	lux	fc	lux	fc	lux	fc
RED LEDs	2,810	261	930	86	496	46	297	28	198	18						
GREEN LEDs	6,110	568	2,160	201	1,126	105	643	60	437	41						
BLUE LEDs	5,760	535	1,930	179	972	90	548	51	368	34						
AMBER LEDs	4,550	423	1,570	146	809	75	475	44	317	29						
FULL ON	19,000	1,765	6,660	619	3,420	318	1,956	182	1,321	123						

DIMENSIONAL DRAWINGS

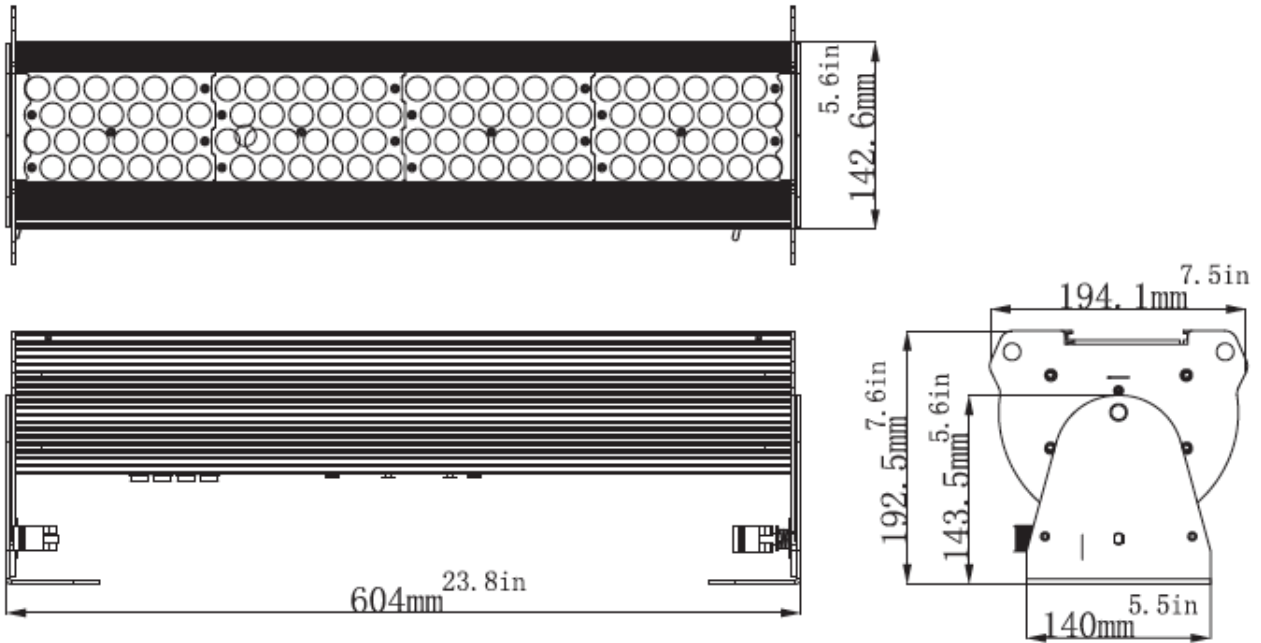

OPTIONAL ACCESSORIES

ORDER CODE	ITEM
TRIGGER CLAMP	Heavy Duty Wrap Around Hook Style Clamp
EWDMSYSTEM	Wireless DMX System (1 Transmitter, 1 Receiver)
EWDMXT	Wireless DMX Transmitter
EWDMXR	Wireless DMX Receiver
PLC3	3' (1m) powerCON PRO Link Cable
AC3PDMX5PRO	5 ft. (1.5m) 3pin PRO DMX Cable
AC5PDMX5PRO	5 ft. (1.5m) 5pin PRO DMX Cable
CAT005	5' (1.5m) CAT6 EtherCON Cable
	Additional Cable Lengths Available

