

SNIPER 2R™

user manual

©2014 ELATION PROFESSIONAL all rights reserved. Information, specifications, diagrams, images, and instructions herein are subject to change without notice. ELATION PROFESSIONAL logo and identifying product names and numbers herein are trademarks of ELATION PROFESSIONAL. Copyright protection claimed includes all forms and matters of copyrightable materials and information now allowed by statutory or judicial law or hereinafter granted. Product names used in this document may be trademarks or registered trademarks of their respective companies and are hereby acknowledged. All non-ELATION brands and product names are trademarks or registered trademarks of their respective companies.

ELATION PROFESSIONAL and all affiliated companies hereby disclaim any and all liabilities for property, equipment, building, and electrical damages, injuries to any persons, and direct or indirect economic loss associated with the use or reliance of any information contained within this document, and/or as a result of the improper, unsafe, insufficient and negligent assembly, installation, rigging, and operation of this product.

Elation Professional USA | 6122 S. Eastern Ave. | Los Angeles, CA. 90040
323-582-3322 | 323-832-9142 fax | www.elationlighting.com |

Elation Professional B.V. | Junostraat 2 | 6468 EW Kerkrade, Netherlands
+31 45 546 85 66 | +31 45 546 85 96 fax | www.elationlighting.eu |

DOCUMENT VERSION



Please check www.elationlighting.com for the latest revision/update of this manual.

Date	Document Version	Software Version	DMX Channel Modes	Notes
12/17/2014	3	A: ≥ 1.4 b: ≥ 1.0	14 / 16 / 18 / 20	Added Speed Modes. (Standard, High).

CONTENTS

General Information	4
Warranty	6
Safety Instructions	7
General Guidelines	8
Discharge Lamp Warning	9
Fixture Overview	10
Lamp Installation Instructions	11
Fixture Installation	20
Understanding DMX	23
Fixture Menu	27
DMX Channel Functions And Values	30
Cleaning and Maintenance	35
Technical Specifications	36
Optional Accessories	38

GENERAL INFORMATION

INTRODUCTION

Congratulations, you have just purchased one of the most innovative and revolutionary new hybrid lighting fixtures on the market today! The **SNIPER 2R™** has been designed to perform reliably for years when the guidelines in this booklet are followed. Please read and understand the instructions in this manual carefully and thoroughly before attempting to operate this unit. These instructions contain important information regarding safety during use and maintenance.

UNPACKING

Thank you for purchasing the **SNIPER 2R™** by Elation Professional®. Every **SNIPER 2R™** has been thoroughly tested and has been shipped in perfect operating condition. Carefully check the shipping carton for damage that may have occurred during shipping. If the carton appears to be damaged, carefully inspect your unit for damage and be sure all accessories necessary to operate the unit have arrived intact. In the event damage has been found or parts are missing, please contact our customer support team for further instructions. Please do not return this unit to your dealer without first contacting customer support at the number listed below. Please do not discard the shipping carton in the trash. Please recycle whenever possible.

BOX CONTENTS

- (1) powerCON Cable
- Manual & Warranty Card

CUSTOMER SUPPORT

Elation Professional® provides a customer support line, to provide set up help and to answer any question should you encounter problems during your set up or initial operation. You may also visit us on the web at www.elationlighting.com for any comments or suggestions. For service related issue please contact Elation Professional®.

ELATION SERVICE USA - Monday - Friday 8:00am to 5:00pm PST

Voice: 323-582-3322

Fax: 323-832-9142

E-mail: support@elationlighting.com

ELATION SERVICE EUROPE - Monday - Friday 08:30 to 17:00 CET

Voice: +31 45 546 85 30

Fax: +31 45 546 85 96

E-mail: support@elationlighting.eu

WARRANTY REGISTRATION

The **SNIPER 2R™** carries a two-year (730 days) limited warranty. Please fill out the enclosed warranty card to validate your purchase. All returned service items whether under warranty or not, must be freight pre-paid and accompany a return authorization (R.A.) number. The R.A. number must be clearly written on the outside of the return package. A brief description of the problem as well as the R.A. number must also be written down on a piece of paper and included in the shipping container. If the unit is under warranty, you must provide a copy of your proof of purchase invoice. Items returned without a R.A. number clearly marked on the outside of the package will be refused and returned at customer's expense. You may obtain a R.A. number by contacting customer support at 323-582-3322.



IMPORTANT NOTICE!

There are no user serviceable parts inside this unit. Do not attempt any repairs yourself; doing so will void your manufactures warranty. Damages resulting from modifications to this fixture and/or the disregard of safety and general user instructions found in this user manual void the manufactures warranty and are not subject to any warranty claims and/or repairs.

2 - YEAR LIMITED WARRANTY

A. Elation Professional® hereby warrants, to the original purchaser, Elation Professional® products to be free of manufacturing defects in material and workmanship for a period of two years, (730 days) from the date of purchase. This warranty shall be valid only if the product is purchased within the United States of America, including possessions and territories. It is the owner's responsibility to establish the date and place of purchase by acceptable evidence, at the time service is sought.

B. For warranty service, send the product only to the Elation Professional® factory. All shipping charges must be pre-paid. If the requested repairs or service (including parts replacement) are within the terms of this warranty, Elation Professional® will pay return shipping charges only to a designated point within the United States. If the entire instrument is sent, it must be shipped in its original package. No accessories should be shipped with the product. If any accessories are shipped with the product, Elation Professional® shall have no liability what so ever for loss of or damage to any such accessories, nor for the safe return thereof.

C. This warranty is void if the serial number has been altered or removed; if the product is modified in any manner which Elation Professional® concludes, after inspection, affects the reliability of the product; if the product has been repaired or serviced by anyone other than the Elation Professional® factory unless prior written authorization was issued to purchaser by Elation Professional®; if the product is damaged because not properly maintained as set forth in the instruction manual.

D. This is not a service contract, and this warranty does not include maintenance, cleaning or periodic check-up. During the period specified above, Elation Professional® will replace defective parts at its expense, and will absorb all expenses for warranty service and repair labor by reason of defects in material or workmanship. The sole responsibility of Elation Professional® under this warranty shall be limited to the repair of the product, or replacement thereof, including parts, at the sole discretion of Elation Professional®. All products covered by this warranty were manufactured after January 1, 1990, and bare identifying marks to that effect.

E. Elation Professional® reserves the right to make changes in design and/or improvements upon its products without any obligation to include these changes in any products theretofore manufactured.

F. No warranty, whether expressed or implied, is given or made with respect to any accessory supplied with products described above. Except to the extent prohibited by applicable law, all implied warranties made by Elation Professional® in connection with this product, including warranties of merchantability or fitness, are limited in duration to the warranty period set forth above. And no warranties, whether expressed or implied, including warranties of merchantability or fitness, shall apply to this product after said period has expired. The consumer's and or Dealer's sole remedy shall be such repair or replacement as is expressly provided above; and under no circumstances shall Elation Professional® be liable for any loss or damage, direct or consequential, arising out of the use of, or inability to use, this product.

G. This warranty is the only written warranty applicable to Elation Professional® Products and supersedes all prior warranties and written descriptions of warranty terms and conditions heretofore published.

SAFETY INSTRUCTIONS



The **SNIPER 2R™** is an extremely sophisticated piece of electronic equipment. To guarantee a smooth operation, it is important to follow the guidelines in this manual. The manufacturer of this device will not accept responsibility for damages resulting from the misuse of this fixture due to the disregard of the information printed in this manual.



This device falls under **PROTECTION CLASS 1**. It's essential this device be grounded properly. Only qualified personnel should perform all electrical connections.

C A U T I O N S



KEEP THIS FIXTURE AWAY FROM RAIN AND MOISTURE!



UNPLUG POWER BEFORE SERVICING FIXTURE!



NEVER TOUCH FIXTURE DURING OPERATION, IT MAY BE HOT!



**NEVER LOOK DIRECTLY INTO THE LIGHT SOURCE!
SENSITIVE PERSONS MAY SUFFER AN EPILEPTIC SHOCK!**

- For proper operation, follow the **Installation** guidelines described in this manual. Only qualified and certified personnel should perform installation of this fixture and only the original rigging parts (brackets) included with this fixture should be used for installation. Any modifications will void the original manufacturer's warranty and increase the risk of damage and/or personal injury.
- Never look directly into the light source of this fixture to prevent risk of injury to your retina, which may induce blindness. Those suffering from **EPILEPSY** should avoid looking directly into the light source of this unit at all times.
- The fan and air inlets must remain clean and never blocked. Allow approx. 6" (15cm) between this fixture and other devices or a wall for proper cooling.
- Always disconnect from main power source before performing any type of service and/or cleaning procedure. Only handle the power cord by the plug end, never pull out the plug by tugging the wire portion of the cord.
- Do not operate this fixture if the power cord has become frayed, crimped and/or damaged. If the power cord is damaged, replace it immediately with a new one of similar power rating.

GENERAL GUIDELINES

- **NEVER OPEN THIS FIXTURE WHILE IN USE!**
- During the initial operation of this fixture, a light smoke or smell may emit from the interior of the fixture. This is a normal process and is caused by excess paint in the interior of the casing burning off from the heat associated with the lamp and will decrease gradually over time.
- This fixture is a professional lighting effect designed for **INDOOR / DRY LOCATIONS ONLY** on stage, in nightclubs, theatres, etc.
- Please make sure there are **NO FLAMMABLE MATERIALS** close to the fixture while operating, to prevent any fire hazard.
- **Minimum** distance to lighted objects must be **16.4 feet (5m)**.
- **Maximum** temp of the external surface **194°F (90°C)**.
- **Minimum** distance of inflammable materials from the surface **1.6 feet (0.5m)**.
- The fixture must be installed in a location with adequate ventilation, at least 1.5 feet (.5m) from adjacent surfaces. Be sure no air ventilation slots are blocked.
- **DO NOT** attempt installation and/or operation without knowledge how to do so.
- **DO NOT** allow operation by persons who are not qualified to operate this type of fixture. Most damages are the result of operations by nonprofessionals.
- Consistent operational breaks may ensure the fixture will function properly for many years to come.
- **DO NOT** shake fixture, avoid brute force when installing and/or operating fixture.
- Always install the fixture with an appropriate safety cable. When installing the fixture in a suspended environment, always use mounting hardware that is no less than M10 x 25 mm, also be sure the hardware is insert in the pre-arranged screw holes in the bracket of the fixture.
- Use the original packaging and materials to transport the fixture in for service.
- **DO NOT TOUCH** the housing bare-hand during its operation. Turn OFF the power and allow approximately 15 minutes for the fixture to cool down before replacing or serving.

DISCHARGE LAMP WARNING

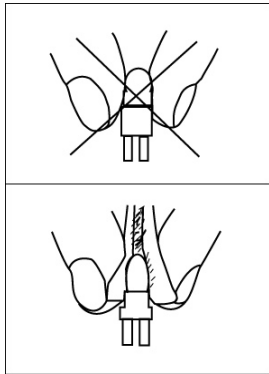

This fixture is fitted with a DISCHARGE LAMP, which is highly susceptible to damage if improperly handled. NEVER touch the lamp with your bare hands, as the oil from your hands will shorten the life of the lamp. Also, NEVER move the fixture until the lamp has had ample time to cool. Lamps are NOT covered under warranty conditions.

Avoid switching the fixture ON and OFF repeatedly in short intervals, as this will reduce lamp life and intensity. To achieve the intensity associated with discharge lamps, these lamps use gas sealed in a high-pressure environment to emit a brilliant output.

 Due to the high pressure involved with the construction of the lamp, the lamp **MAY EXPLODE DURING PROLONGED EXTENSIVE USE**. This risk is increased with age; added care is encouraged when dealing with older lamps. Thus, the lamp must always be replaced at the end of their recommended duty cycle. Extreme caution should be used when operating this or any fixture fitted with a gas discharge lamp.



U V R A D I A T I O N N O T I C E

This fixture emits intense UV radiation, which is harmful to the eyes and skin. The intense luminance of the lamp can cause severe damage to the retina. NEVER operate this fixture with ANY of the protective covers removed. These covers have been specially designed to shield against UV radiation.



L A M P R E P L A C E M E N T

Please note that due to the nature of the Phillips™ Platinum 2R Lamp and the optical path of the Elation SNIPER 2R™ fixture, the lamp **MUST BE** replaced at 6,000 hours.

Use only Genuine Original Phillips™ platinum lamps. Other brand lamps may cause damage and void warranty!

FIXTURE OVERVIEW

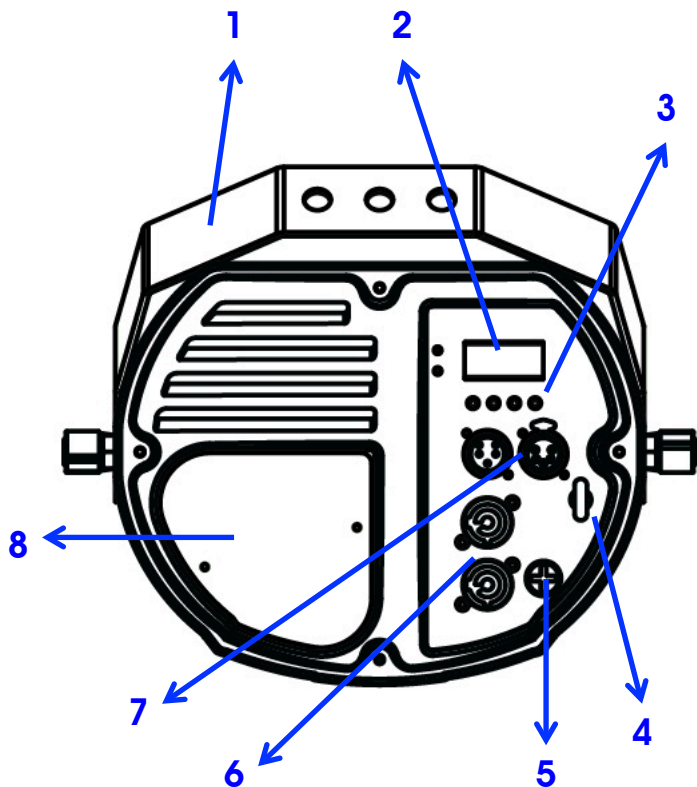

1. Adjustable Mounting Yoke
2. LCD Menu Function Display
3. MENU, DOWN, UP, ENTER Buttons
4. Safety Cable Attachment Hook
5. FUSE
6. powerCON IN/OUT
7. 5pin DMX IN/OUT
8. Lamp Cover Plate
9. Lens

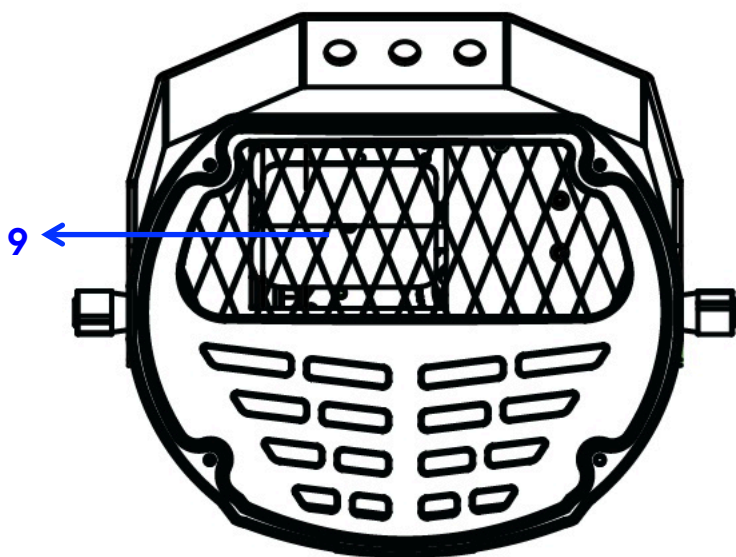

LAMP INSTALLATION INSTRUCTIONS



LAMP REPLACEMENT

Please note that due to the nature of the Phillips™ Platinum 2R Lamp and the optical path of the Elation SNIPER 2R fixture, the lamp **MUST BE** replaced at 6,000 hours.

Use only Genuine Original Phillips™ Platinum 2R Lamps. Other brand lamps may cause damage and void warranty!

INSTALLING OR REPLACING THE LAMP

To ensure a proper/safe lamp change, carefully read all the following instructions.



LAMP SAFETY INSTRUCTIONS

- **ALWAYS** replace lamp after 6,000 Hours.
- Use only Genuine Original Phillips™ Platinum 2R lamps. Other brand lamps may cause damage and void the warranty!
- NEVER touch the lamp with your bare hands, as the oil from your hands will shorten the life of the lamp.
- Always disconnect the fixture's main power supply before replacing lamp.
- Allow fixture to cool for at least 15 minutes before attempting any type of service.
- Make sure ALL covers/panels are replaced/secured before operating the fixture to prevent any risk and/or damage to eye retina from UV Radiation exposure!

LAMP INSTALLATION PROCEDURE

1. Remove **(2)** screws on lamp cover plate as indicated below.



LAMP INSTALLATION PROCEDURE - continued

- Remove lamp cover plate to access the lamp.

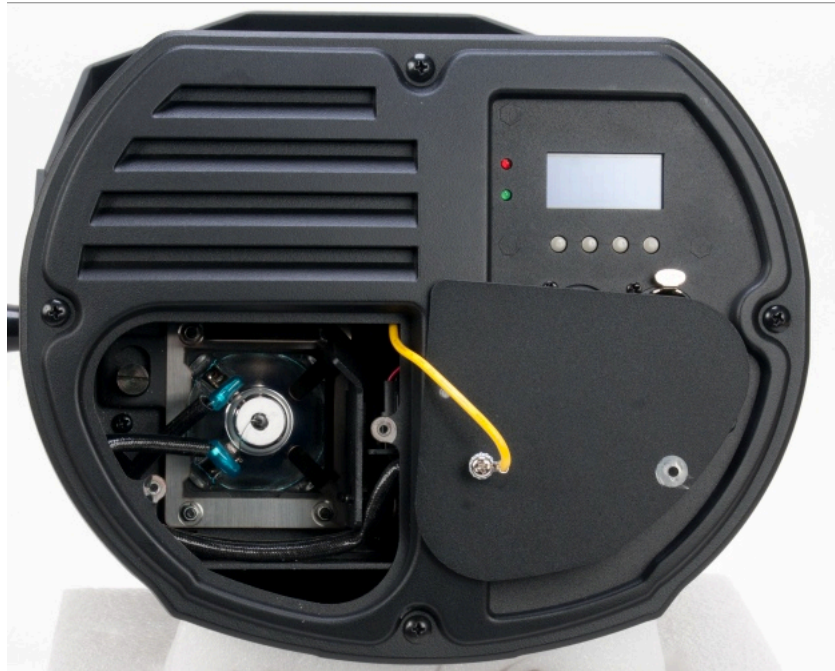

- Gently remove **(2) Black Wires** connected to spade terminals on base of lamp.



LAMP INSTALLATION PROCEDURE - continued

- Using your thumb, gently push the base of the lamp towards the **RIGHT** to release.



- Once lamp is released, grab the lamp base with your thumb and index finger and gently pull the lamp **OUT** towards the **LEFT** and **AWAY** from the fixture.



LAMP INSTALLATION PROCEDURE - continued



6. Using a clean cloth or gloves, gently install the new lamp into the fixture using your thumb and index finger, making sure the spade terminals on the base of the lamp are facing towards the **LEFT**.



LAMP INSTALLATION PROCEDURE - continued

7. Seat the **RIGHT** edge of the lamp under the (2) retention clips first, then using your thumb, gently push the lamp base towards the **RIGHT** and **DOWN** until the lamp locks into place.

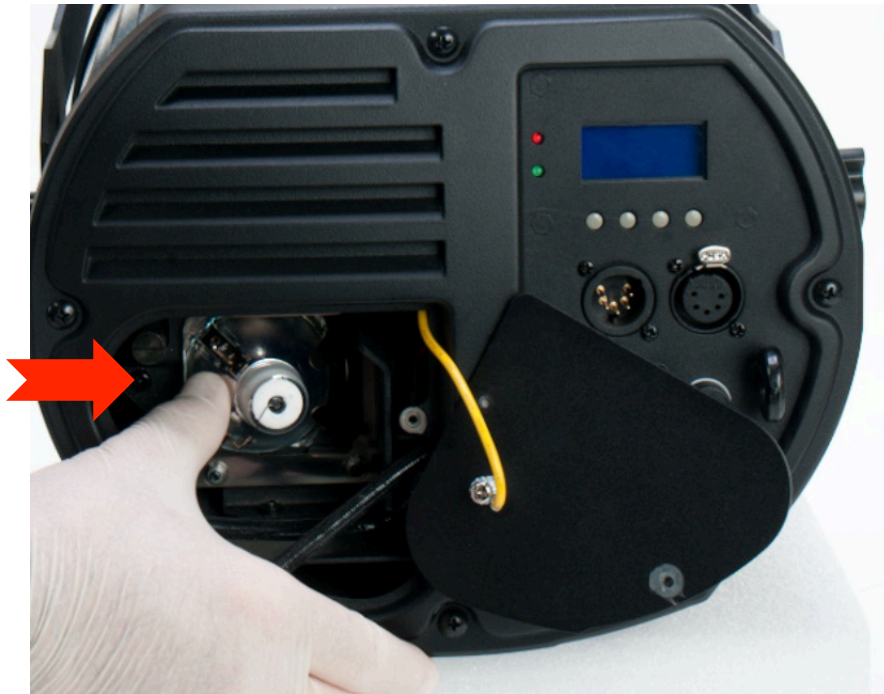

8. Make sure the lamp is properly seated into place just like the old lamp was.



LAMP INSTALLATION PROCEDURE - continued

9. Gently attach the **(2) Black Wires** to spade terminals on the base of the lamp.

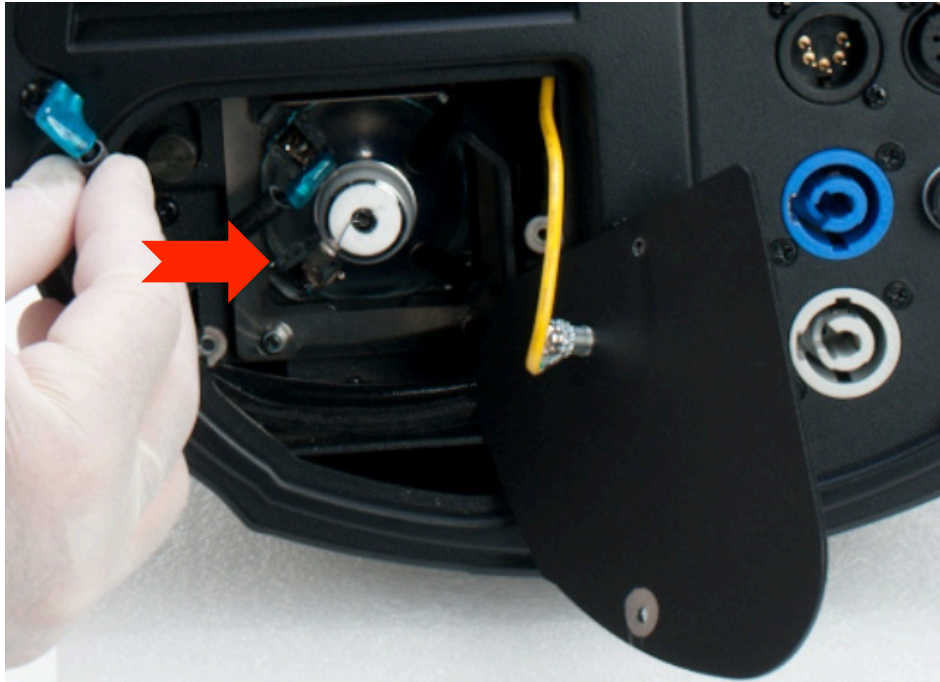

10. Make sure each wire is securely attached to the lamp.

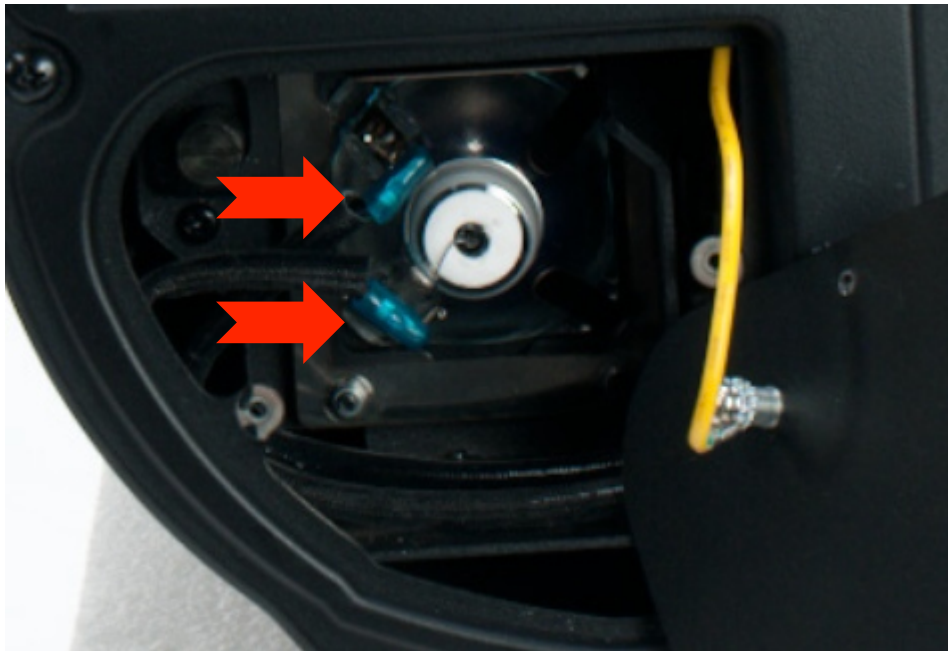

LAMP INSTALLATION PROCEDURE - continued

11. Replace the lamp cover plate back into place by securing the **(2)** screws.



12. Power fixture **ON** and make sure the lamp strikes **ON**.

LAMP HOURS RESET PROCEDURE

1. Access the main menu by pressing the **MENU** button and then pressing the **UP** or **DOWN** buttons until "**LAMP RESET TIME**" is displayed.
2. Press the **ENTER** button and then press the **UP** or **DOWN** to until "**YES**" is displayed.
3. Press the **ENTER** button to select "**YES**". The lamp timer has now been reset.
4. Press the **MENU** button to exit and return to the home screen.



LAMP OPTIMIZATION

Unlike traditional discharge lamps the **Phillips™ Platinum 2R Lamp** does **NOT** require optimization. The lamp orientation and optimization procedure has been preset during the manufacturing process of the lamp. Please remember the **Phillips™ Platinum 2R Lamp** is **NOT** a hot-restrike lamp therefore, therefore you must wait approximately **15 minutes** before you can attempt to restrike the lamp once it has been turned off.

FIXTURE INSTALLATION



FLAMMABLE MATERIAL WARNING

Keep fixture at least 5.0 ft. (1.5m) away from any flammable materials, decorations, pyrotechnics, etc.



ELECTRICAL CONNECTIONS

A qualified electrician should be used for all electrical connections and/or installations.

CAUTIONS

- For added protection, mount the fixture in areas outside walking paths, seating areas, or in areas where unauthorized personnel might reach the fixture.
- Max ambient operating temperature for this fixture is **104°F. (40°C)**
Do not use the fixture under or above this temperature.
- Before mounting the fixture to any surface, make sure the installation area can hold a minimum point load of 10 times the weight of the fixture. **(210 lbs / 95 kg)**
- Fixture installation must always be secured with a secondary safety attachment, such as an appropriate safety cable.
- Never stand directly below the device when mounting, removing or servicing.

POWER LINKING

Max number of units that can be power linked is **7 units @120V / 14 units @230V.**



W A R N I N G

MINIMUM distance to lighted objects must be 16.5 feet (5m)

MAXIMUM temperature of external surface 194° F (90° C)

MINIMUM distance of inflammable materials from surface 1.6 feet (0.5m)

Keep fixture at least 5.0 feet (1.5m) away from any flammable materials, decorations, pyrotechnics, etc.

MOUNTING POINTS

- Overhead mounting requires extensive experience, including amongst others calculating working load limits, installation material being used, and periodic safety inspection of all installation material and the device. If you lack these qualifications, do not attempt the installation yourself. Improper installation can result in bodily injury.
- Fixture is fully operational in the specific mounting positions as illustrated below.

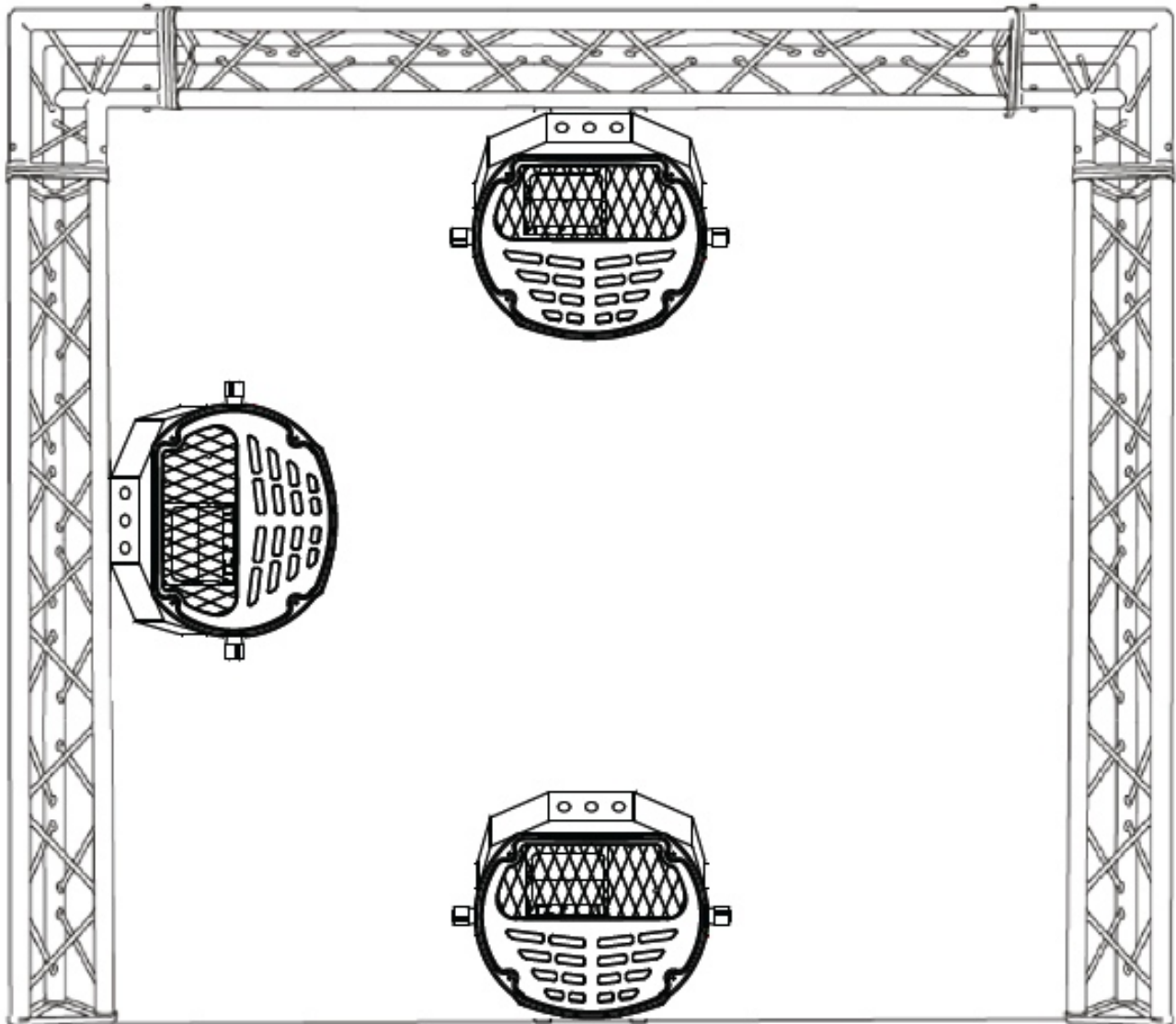

SAFETY CABLE

Always use a Safety Cable whenever installing this fixture in a suspended environment to ensure the fixture will not drop if the clamp fails.

CLAMP MOUNTING

The **SNIPER 2R™** includes an adjustable mounting yoke that attaches to both sides of the fixture. When mounting this fixture to truss be sure to secure an appropriately rated clamp to the mounting yoke using a M10 screw fitted through the center hole of the mounting yoke. Be sure to attach a **Safety Cable** to the fixture using the safety cable rigging point on the back panel.

SECURING

Regardless of the rigging option you choose for your **SNIPER 2R™** always be sure to secure your fixture with a safety cable. The fixture provides a built-in rigging point for a safety cable on the back of the fixture as illustrated below. Be sure to only use the designated rigging point for the safety cable.



UNDERSTANDING DMX

DMX-512

DMX is short for Digital Multiplex. This is a universal protocol used by most lighting and controller manufactures as a form of communication between intelligent fixtures and controllers. DMX allows all makes and models of different manufactures to be linked together and operate from a single controller. This is possible as long as all the fixtures and the controller are DMX compliant. A DMX controller sends the DMX data instructions to the fixture allowing the user to control the different aspects of an intelligent light. DMX data is sent out as serial data that travels from fixture to fixture via data "IN" and data "OUT" XLR terminals located on the fixtures (most controllers will only have output jacks).

DMX LINKING

To ensure proper DMX data transmission, always use proper DMX cables and a terminator. When using several DMX fixtures try to use the shortest cable path possible. Never split a DMX line with a "Y" style connector. The order in which the fixtures are connected in a DMX line does not influence the DMX addressing. For example; a fixture assigned a starting DMX address of 1 may be placed anywhere in the DMX chain, at the beginning, at the end, or anywhere in the middle. The DMX controller knows to send data assigned to address 1 to that fixture no matter where it is located in the DMX chain. The **SNIPER 2R™** can be controlled via DMX-512 protocol and the DMX address is set via the control menu.

DATA CABLE (DMX Cable) REQUIREMENTS (For DMX and Master/Slave Operation)

Your fixture and your DMX controller require a standard 3pin or 5pin XLR connector for data input and data output (see figure below). If you are making your own cables, be sure to use two conductor, shielded digital DMX cable rated at 120 ohms; this cable is designed for DMX transmission and may be purchased from your Elation dealer or at most professional lighting retailers. Your cables should be made with a male and female XLR connector on either end of the cable. Also, remember that a DMX line must be daisy chained and cannot be split, unless using an approved DMX splitter such as **Elation's Opto Branch 4™, Opto Branch 8™, or DMX-Branch/4™**.

DMX Output
3-Pin XLR Socket



DMX Input
3-Pin XLR Socket



- 1: Ground
- 2: Data (-)
- 3: Data (+)

DMX Output
5-Pin XLR Socket



DMX Input
5-Pin XLR Socket

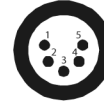

- 1: Ground
- 2: Data (-)
- 3: Data (+)
- 4: Open
- 5: Open



Be sure to follow the above figure when making your own cables. Do not use the ground lug on the XLR connector. Do not connect the cable's shield conductor to the ground lug or allow the shield conductor to come in contact with the XLR outer casing. Grounding the shield could cause a short circuit and erratic behavior.

DMX-512 CONTROLLER CONNECTION

Connect the provided XLR cable to the female XLR output of your controller and the other side to the male XLR input of the **SNIPER 2R™**. The diagram below illustrates a typical DMX-512 connection when the fixture is in the **20 Channel Mode**. You can chain multiple panels together through serial linking. The cable that should be used is two conductor, shielded DMX cable with XLR input and output connectors. Always be sure daisy chain your in and out data connections, never split or "Y" your DMX connections unless you are using an approved DMX splitter such as **Elation's Opto Branch 4™, Opto Branch 8™, or DMX-Branch/4™**.

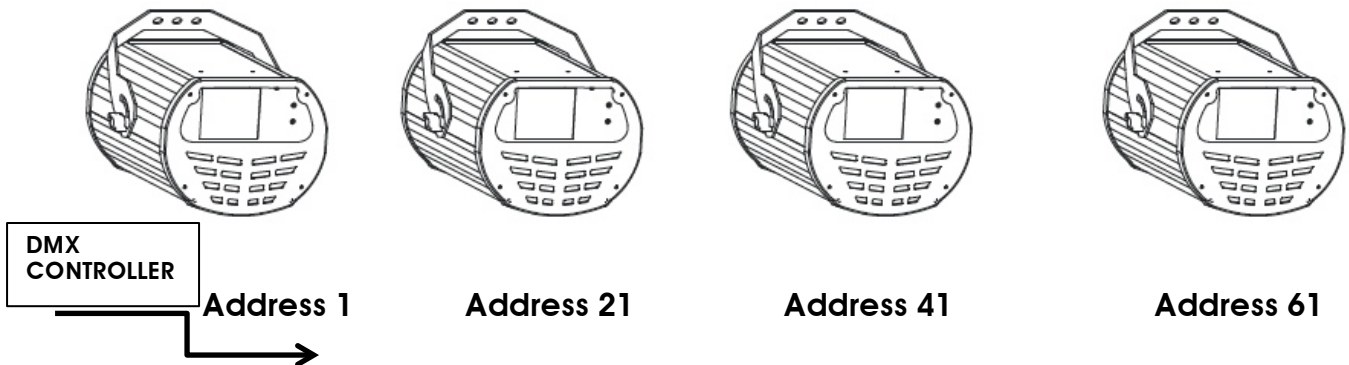

DMX-512 CONNECTION WITH DMX TERMINATOR

A DMX terminator should be used in all DMX lines especially in longer runs. The use of a terminator may avoid erratic behavior in your DMX line. A terminator is a 120 ohm 1/4 watt resistor that is connected between pins 2 and 3 of a male XLR connector (DATA + and DATA -). This fixture is inserted in the female XLR connector of the last fixture in your daisy chain to terminate the line. Using a line terminator will decrease the possibilities of erratic behavior.

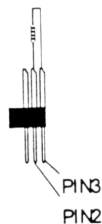
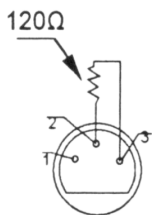

Termination reduces signal errors and avoids signal transmission problems and interference. It is always advisable to connect a DMX terminal, (Resistance 120 Ohm 1/4 W) between PIN 2 (DMX-) and PIN 3 (DMX +) of the last fixture.

5pin XLR DMX CONNECTORS

Some manufactures use 5pin XLR connectors for DATA transmission in place of 3pin. 5pin XLR fixtures may be implemented in a 3pin XLR DMX line. When inserting standard 5pin XLR connectors in to a 3pin line a cable adaptor must be used, these adaptors are readily available at most electric stores. The following chart details a proper cable conversion.

3-Pin XLR to 5-Pin XLR Conversion		
Conductor	3-Pin XLR Female (Out)	5-Pin XLR Male (In)
Ground/Shield	Pin 1	Pin 1
Data Compliment (- signal)	Pin 2	Pin 2
Data True (+ signal)	Pin 3	Pin 3
Not Used		Pin 4 - Do Not Use
Not Used		Pin 5 - Do Not Use

DMX ADDRESSING

All fixtures should be given a DMX starting address when using a DMX controller, so the correct fixture responds to the correct control signal. This digital starting address is the channel number from which the fixture starts to “listen” to the digital control information sent out from the DMX controller. The allocation of this starting DMX address is achieved by setting the correct DMX address on the digital display located on the back of the fixture.

You can set the same starting address for all fixtures or a group of fixtures, or set different address for each individual fixture. Be advised that setting all fixtures to the same DMX address will subsequently control all fixtures in the same fashion, in other words, changing the settings of one channel will affect all the fixtures simultaneously.

If you set each fixture to a different DMX address, each unit will start to “listen” to the channel number you have set, based on the quantity of control channels (DMX channels) of each fixture. That means changing the settings of one channel will only affect the selected fixture.

In the case of the **SNIPER 2R™**, when in the **20 Channel Mode** you should set the starting DMX address of the first unit to 1, the second unit to 21 (1 + 20), the third unit to 41 (21 + 20), the fourth unit to 61 (41 + 20), and so on.

Note: During start-up the **SNIPER 2R™** will automatically detect whether a DMX data signal is being received or not. If your fixture is connected to a DMX controller and it is not receiving a DMX signal, please check the following:

- The 5pin XLR input plug (cable with DMX signal from controller) is not connected or is not inserted completely into the DMX input jack of the fixture.
- The DMX controller is switched off or defective.
- The DMX cable or connector is defective.
- A DMX terminator has been inserted into the last fixture in your DMX chain.

FIXTURE MENU

ON-BOARD SYSTEM MENU

The **SNIPER 2R™** comes with an easy to navigate system menu. The next section will detail the functions of each command in the system menu.

LCD MENU CONTROL PANEL

The control panel (see image below) located on back of the fixture allows you to access the main menu and make all necessary adjustments to the **SNIPER 2R™**. During normal operation, pressing **MENU** button once will access the fixture's main menu. Once in the main menu you can navigate through the different functions and access the sub-menus with the **UP** and **DOWN** buttons. Once you reach a field that requires adjusting, press the **ENTER** button to activate that field and use the **UP** and **DOWN** buttons to adjust the field. Pressing the **ENTER** button once more will confirm your setting. You may exit the main menu at any time without making any adjustments by pressing and holding the **MENU** button for 3 seconds.



ELATION© SNIPER 2R™ M A I N M E N U - V E R S I O N 3		
Specifications are subject to change without any prior written notice.		
MENU	OPTIONS / VALUES	DESCRIPTION
DMX Address	(1) - (512)	Set DMX Address
Channel Mode	14 chan:, 16 chan:, 18 chan:, 20 chan:	Set DMX Channel Mode
DMX State	Blackout, Last State	Set How Fixture Reacts to Loss of DMX Signal or Power
Back Light	Off, On	Turn LCD Display Back Light On/Off
Pan Invert	Normal, Invert	Invert (flip) PAN Control 180°
Tilt Invert	Normal, Invert	Invert (flip) TILT Control 180°
Auto Test	On, Off	Run Self-Test Using Internal Programs
Speed Mode	Standard, High	Set Speed Mode (see note below for more details)
Lamp On/Off	On, Off	Turn Lamp On/Off
Lamp Power On	On, Off	Set Lamp State While Power is On
Lamp Off Via DMX	On, Off	Turn Lamp Off Via External DMX Controller
Lamp On Via DMX	On, Off	Turn Lamp On Via External DMX Controller
Lamp Off if DMX Off	On, Off	Lamp Turns Off When DMX Signal is Lost
Lamp Delay	0s - 255s	Set Delay Time Between Power On and Lamp On
Lamp Time		Displays Total Lamp Usage Time
Reset Lamp Time	Yes, No	Resets the Total Lamp Run Time
Fixture Time		Displays Total Fixture Run Time
Firmware Version		Displays Software Version of Fixture
Defaults	Yes, No	Return All Settings Back to Factory Default
Reset		Reset All Motors

SPEED MODE

The fixture movement speed can be set to **STANDARD** (default) or **HIGH**.

STANDARD mode is recommended for overall effect usage.

HIGH mode is recommended for aerial laser-like effect usage.

OFFSET ADJUSTMENTS – Calibration



ONLY QUALIFIED TECHNICIANS SHOULD PERFORM THESE FUNCTIONS.

This function allows small adjustments to be made to the PAN and TILT home positions, the ECCENTRIC drive, the COLOR and GOBO wheels, the SHUTTER, PRISM and PRISM ROTATION effects, to compensate for wear and/or in the event a sensor has been knocked slightly out of place.

To access the **OFFSET ADJUSTMENTS MENU** press and release the **MENU** button and immediately press and hold the **ENTER** button for at least 5 seconds. The fixture will now be in the **OFFSET ADJUSTMENTS MENU** where you can make adjustments to the functions listed below.

To exit the **OFFSET ADJUSTMENTS MENU** press and hold the **MENU** button for at least 3 seconds, until the display shows **ELATION SNIPER**.



SHUTTER AND BEAM POSITION AFTER EXITING OFFSET ADJUSTMENTS MENU

The **SHUTTER** and **BEAM POSITION** after exiting the **OFFSET ADJUSTMENT MENU** will depend on the **DMX STATE** setting (“Blackout” or “Last State”) and/or if the fixture is receiving a DMX signal.

ELATION© SNIPER 2R™		
OFFSET ADJUSTMENTS MENU - VERSION 3		
Specifications are subject to change without any prior written notice.		
MENU	OPTIONS / VALUES	DESCRIPTION
Pan Offset	(0) - (255)	Adjustment The PAN Home Position
Tilt Offset	(0) - (255)	Adjustment The TILT Home Position
Eccentri	(-127) - (127)	Adjustment of the Eccentric Drive
Color Offset	(-127) - (127)	Adjustment of the Color Wheel
Gobo Offset	(-127) - (127)	Adjustment of the Gobo Wheel
Shutter Offset	(0) - (255)	Adjustment of the Shutter
Rprism Offset	(-127) - (127)	Adjustment of the Prism Rotation
Prism Offset	(-127) - (127)	Adjustment of the Prism

DMX CHANNEL FUNCTIONS AND VALUES

ELATION© SNIPER 2R™

DMX Channel Values / Functions Version 3 (20 DMX Channels)

Specifications are subject to change without any prior written notice.

*Rotation direction of effects depends on the orientation of the fixture head.

MODE / CHANNEL				VALUE	FUNCTION
14	16	18	20		
1	1				PAN
				0-127	PAN Movement
				128-255	PAN Shaking Movement SLOW to FAST
		1	1		PAN
				0-255	PAN Movement
	2	2	2		PAN FINE [16 BIT]
				0-255	PAN Movement FINE [16bit]
2	3				TILT
				0-127	TILT Movement
				128-255	TILT Shaking Movement SLOW to FAST
		3	3		TILT
				0-255	TILT Movement
	4	4	4		TILT FINE [16 BIT]
				0-255	TILT Movement FINE
		5	5		PAN SHAKING MOVEMENT SPEED
				0-255	PAN Shaking Movement SLOW to FAST
		6	6		TILT SHAKING MOVEMENT SPEED
				0-255	TILT Shaking Movement SLOW to FAST
3	5	7	7		COLORS
				0-2	WHITE
				3-4	Split WHITE / LIGHT RED
				5-6	LIGHT RED
				7-8	Split LIGHT RED / BLUE
				9-11	BLUE
				12-13	Split BLUE / GREEN
				14-15	GREEN
				16-17	Split GREEN / YELLOW
				18-20	YELLOW
				21-22	Split YELLOW / ORANGE
				23-24	ORANGE
				25-26	Split ORANGE / MAGENTA
				27-29	MAGENTA
				30-31	Split MAGENTA / LAVENDAR
				32-33	LAVENDAR
				34-35	Split LAVENDAR / LIGHT PINK
				36-38	LIGHT PINK
				39-40	Split LIGHT PINK / YELLOW-GREEN
				41-42	YELLOW GREEN
43-44	Split YELLOW-GREEN / PEACOCK BLUE				
45-47	PEACOCK BLUE				
48-49	Split PEACOCK BLUE / MEDIUM PINK				
50-51	MEDIUM PINK				

ELATION© SNIPER 2R™					
DMX Channel Values / Functions Version 3 (20 DMX Channels)					
Specifications are subject to change without any prior written notice.					
*Rotation direction of effects depends on the orientation of the fixture head.					
MODE / CHANNEL				VALUE	FUNCTION
14	16	18	20		
					COLORS [continued]
3	5	7	7	52-53	Split MEDIUM PINK / MEDIUM PURPLE
				54-56	MEDIUM PURPLE
				57-58	Split MEDIUM PURPLE / PINEAPPLE YELLOW
				59-60	PINEAPPLE YELLOW
				61-62	Split PINEAPPLE YELLOW / CONGO BLUE
				63-65	CONGO BLUE
				66-67	WHITE
				68-128	Color Wheel Index - WHITE to CONGO BLUE
				129-190	*Clockwise Color Rotation from FAST to SLOW
				191-193	STOP
				194-255	*Counterclockwise Color Rotation from SLOW to FAST
4	6	8	8		GOBOS
				0-7	OPEN
				8-14	Gobo 1
				15-22	Gobo 2
				23-29	Gobo 3
				30-37	Gobo 4
				38-44	Gobo 5
				45-52	Gobo 6
				53-59	Gobo 7
				60-67	Gobo 8
				68-74	Gobo 9
				75-82	Gobo 10
				83-89	Gobo 11
				90-97	Gobo 12
				98-104	Gobo 13
				105-112	Gobo 14
				113-119	Gobo 15
				120-126	Gobo 16
				127-133	Gobo 17
				134-194	*Clockwise Gobo Wheel Rotation From FAST to SLOW
195-255	*Counterclockwise Gobo Wheel Rotation From SLOW to FAST				

ELATION© SNIPER 2R™					
DMX Channel Values / Functions Version 3 (20 DMX Channels)					
Specifications are subject to change without any prior written notice.					
*Rotation direction of effects depends on the orientation of the fixture head.					
MODE / CHANNEL				VALUE	FUNCTION
14	16	18	20		
5	7	9	9		PATTERN MACROS
				0-8	OFF
				9-16	Pattern Macro 1
				17-25	Pattern Macro 2
				26-33	Pattern Macro 3
				34-42	Pattern Macro 4
				43-50	Pattern Macro 5
				51-59	Pattern Macro 6
				60-67	Pattern Macro 7
				68-76	Pattern Macro 8
				77-84	Pattern Macro 9
				85-93	Pattern Macro 10
				94-101	Pattern Macro 11
				102-110	Pattern Macro 12
				111-118	Pattern Macro 13
				119-127	Pattern Macro 14
				128-135	Pattern Macro 15
				136-144	Pattern Macro 16
				145-152	Pattern Macro 17
				153-161	Pattern Macro 18
				162-169	Pattern Macro 19
				170-178	Pattern Macro 20
				179-186	Pattern Macro 21
				187-195	Pattern Macro 22
				196-203	Pattern Macro 23
				204-212	Pattern Macro 24
				213-220	Pattern Macro 25
				221-229	Pattern Macro 26
				230-237	Pattern Macro 27
238-246	Pattern Macro 28				
247-255	Pattern Macro 29				
6	8	10	10		PATTERN ROTATION - *CLOCKWISE / *COUNTERCLOCKWISE
				0-9	STOP
				10-120	*Clockwise Pattern Rotation from FAST to SLOW
				126-141	STOP
				142-245	*Counterclockwise Pattern Rotation from SLOW to FAST
				246-255	STOP
7	9	11	11		PATTERN ROTATION - *HORIZONTAL / *VERTICAL
				0-9	STOP
				10-120	*Horizontal Pattern Rotation from FAST to SLOW
				121-134	STOP
				135-245	*Vertical Pattern Rotation from SLOW to FAST
246-255	STOP				

ELATION© SNIPER 2R™					
DMX Channel Values / Functions Version 3 (20 DMX Channels)					
Specifications are subject to change without any prior written notice.					
*Rotation direction of effects depends on the orientation of the fixture head.					
MODE / CHANNEL				VALUE	FUNCTION
14	16	18	20		
8	10	12	12		PATTERN ZOOM
				0-127	Pattern ZOOM Manual
				128-255	Pattern ZOOM SLOW to FAST
9	11	13	13		BEAM ROTATION
				0-63	0° to 360°
				64-127	Shaking
				128-189	*Clockwise Rotation FAST to SLOW
				190-193	STOP
194-255	*Counterclockwise Rotation SLOW to FAST				
10	12	14	14		PRISM
				0-7	PRISM OFF
				8-255	PRISM ON
11	13	15	15		PRISM ROTATION
				0-127	PRISM Indexing
				128-189	*Clockwise PRISM Rotation FAST to SLOW
				190-193	STOP
194-255	*Counterclockwise PRISM Rotation SLOW to FAST				
12	14	16	16		SHUTTER, STROBE
				0-7	BLACKOUT
				8-15	OPEN
				16-131	STROBE SLOW to FAST
				132-139	OPEN
				140-181	FAST OPEN to SLOW CLOSE
				182-189	OPEN
				190-231	FAST CLOSE to SLOW OPEN
				232-239	OPEN
240-247	RANDUM STROBE				
248-255	OPEN				
13	15	17	17		DIMMER INTENSITY
				0-255	Dimmer Intensity 0 to 100%
14	16	18	18		FUNCTIONS
				0-39	NO FUNCTION
				40-59	LAMP ON
				60-79	LAMP OFF
				80-84	ALL MOTORS Reset
				85-87	PAN / TILT Motors Reset
				88-90	COLOR Motor Reset
				91-93	GOBO Motor Reset
				94-96	SHUTTER & DIMMER Motors Reset
				97-99	OTHER Motors Reset
				100-109	ENABLE BLACKOUT WHILE PAN/TILT MOVEMENT
				110-119	ENABLE BLACKOUT WHILE COLOR CHANGE
				120-129	ENABLE BLACKOUT WHILE GOBO CHANGE
130-255	NO FUNCTION				

ELATION© SNIPER 2R™					
DMX Channel Values / Functions Version 3 (20 DMX Channels)					
Specifications are subject to change without any prior written notice.					
*Rotation direction of effects depends on the orientation of the fixture head.					
MODE / CHANNEL				VALUE	FUNCTION
14	16	18	20		
			19		PAN SHAKING MOVEMENT RANGE
				0-255	PAN SHAKING Movement Range Adjustment
			20		TILT SHAKING MOVEMENT RANGE
				0-255	TILT SHAKING Movement Range Adjustment

CLEANING AND MAINTENANCE



C A U T I O N

Disconnect power before cleaning or maintenance.

CLEANING

Frequent cleaning is recommended to insure proper function, optimized light output, and an extended life. The frequency of cleaning depends on the environment in which the fixture operates: damp, smoky or particularly dirty environments can cause greater accumulation of dirt on the fixture's optics.

- Clean the external lens surface at least every 20 days with a soft cloth to avoid dirt/debris accumulation. Never use alcohol, solvents, or ammonia based cleaners.

MAINTENANCE

Regular inspections are recommended to insure proper function and extended life. There are no user serviceable parts inside this fixture, please refer all other service issues to an authorized Elation service technician. Should you need any spare parts, please order genuine parts from your local Elation dealer.

Please refer to the following points during routine inspections:

- A detailed electric check by an approved electrical engineer every 3 months, to make sure the circuit contacts are in good condition and prevent overheating.
- Be sure all screws and fasteners are securely tightened at all times. Loose screws may fall out during normal operation resulting in damage or injury.
- Check for any deformations on the housing, color lenses, rigging hardware and rigging points (ceiling, suspension, trussing). Deformations in the housing could allow for dust to enter into the fixture. Damaged rigging points or unsecured rigging could cause the fixture to fall and seriously injure a person(s).
- Inspect all moving parts and make sure there are no signs of wear and rotate/move without imbalances.
- Electric power supply cables must not show any damage, material fatigue or sediments. Never remove the ground prong from the power cable.

TECHNICAL SPECIFICATIONS

FEATURES

Multi Effect Luminaire, Beam, Scanner, Laser Simulator
3° Precision Beam
3 Facet Rotating Prism
X / Y and Z High-Speed Mirror System

SOURCE

132W Platinum 2R Lamp
6,000 Hour Average Life

EFFECTS

Strobe
Electronic Dimmer
3 Facet Rotating Prism
Multiple Pattern Macros

COLOR

(14) Dichroic Colors + White

GOBOS

(17) Gobos + Open

CONTROL / CONNECTIONS

(4) DMX Channel Modes (14 / 16 / 18 / 20)
4 Button Control Panel
5pin DMX In/Out
powerCON In/Out

SIZE / WEIGHT

Length: 14.2" (361mm)
Width: 12.0" (305mm)
Vertical Height: 11.6" (295mm)
Weight: 21.0 lbs. (9.5 kg)

ELECTRICAL / THERMAL

AC 100-240V - 50/60Hz
220W Max Power Consumption
Multiple Unit Power Linking (max 7 @120V / 14 @230V)
104°F (40°C) Max Ambient Temperature

APPROVALS / RATINGS

CE | IP20

Please Note: Specifications and improvements in the design of this unit and this manual are subject to change without any prior written notice.

COLORS



GOBOS



PHOTOMETRIC DATA

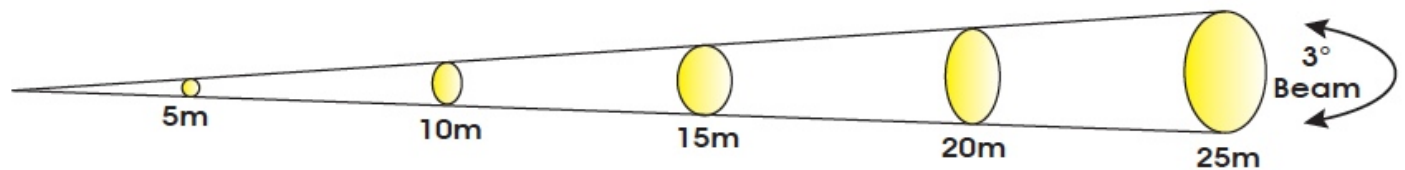

	5m		10m		15m		20m		25m	
	m	ft	m	ft	m	ft	m	ft	m	ft
Distance	5	16.4	10	32.8	15	49.2	20	65.6	25	82.0
3° Beam Diameter	0.25	0.8	0.49	1.6	0.74	2.4	1.02	3.3	1.26	4.1
Photometrics	lux	fc	lux	fc	lux	fc	lux	fc	lux	fc
FULL ON	45,010	4,181	12,050	1,119	5,633	523	3,178	295	2,278	212

Please Note: Specifications and improvements in the design of this unit and this manual are subject to change without any prior written notice.

DIMENSIONAL DRAWINGS

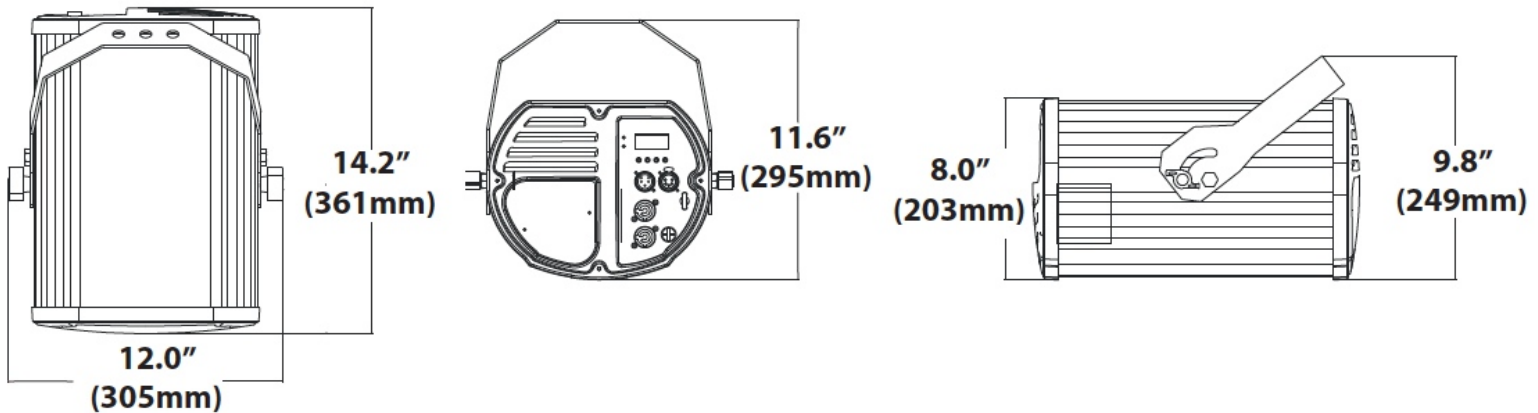

Please Note: Specifications and improvements in the design of this unit and this manual are subject to change without any prior written notice.

OPTIONAL ACCESSORIES

ORDER CODE	ITEM
TRIGGER CLAMP	Heavy Duty Wrap Around Hook Style Clamp
DRCSNIPER	Six-Pack Road Case For Sniper 2R™
EWDMSYSTEM	Wireless DMX System (1 Transmitter, 1 Receiver)
EWDMXT	Wireless DMX Transmitter
EWDMXR	Wireless DMX Receiver
PLC3	3' (1m) powerCON PRO Link Cable
PLC6	6' (1.8m) powerCON PRO Link Cable
AC5PDMX5PRO	5 ft. (1.5m) 5pin PRO DMX Cable
	Additional Cable Lengths Available

