

AMERICAN AUDIO MCD-710

Professional Dual Mp3
Compact Disc Player

Featuring:



User Guide
and Reference Manual

AMERICAN AUDIO
4295 Charter Street
Los Angeles Ca. 90058
www.americanaudio.us

CONTENTS

SAFETY PRECAUTIONS.....	3
ELECTRICAL PRECAUTIONS.....	4
SAFETY INSTRUCTIONS.....	5
VOLTAGE SELECTOR.....	5
UNPACKING.....	6
CUSTOMER SUPPORT.....	6
FEATURES.....	7
SET-UP INSTALLATION.....	8
FUNCTIONS AND CONTROLS	
CONTROLLER UNIT.....	9
TRANSPORT UNIT.....	12
VFD DISPLAY.....	14
BASIC OPERATIONS	
LOADING EJECTING DISC.....	15
SELECTING TRACKING.....	15
STARTING PLAYBACK.....	16
PAUSING PLAYBACK.....	16
FRAME SEARCH.....	17
SETTING A CUE POINT.....	17
CREATING A SEAMLESS LOOP.....	18
CHANGING TIME DISPLAY.....	20
SYSTEM MEMORY.....	21
PITCH ADJUSTMENTS	
PITCH SLIDER.....	22
PITCH BENDING.....	23
BOP EFFECT.....	25
ACCESSING MP3 FOLDERS.....	26
FLIP-FLOP™.....	27
HANDLING COMPACT DISCS.....	29
WARRANTY.....	30
SPECIFICATIONS.....	31

FOR BEST CD-R DISC PLAYBACK RESULTS IN THIS CD PLAYER PLEASE FOLLOW THESE GUIDELINES:

1. High quality CD-R Audio discs (should conform to the standards of the Orange Book 2).
2. Use a high quality bit rate when recording discs. (At least 160kbps)
3. Record discs in the slowest speed possible. (i.e. 2x or 4x speed)

Please Note: All specifications and improvements to and in the design of this unit and this manuals are subject to change at any time without any prior written or published noticed.

For service parts visit <http://parts.americandj.com>

IMPORTANT SAFETY PRECAUTIONS

IMPORTANT SAFETY ITEMS FOR U.S.A. & CANADA MODEL ONLY

NOTE:

This CD player uses a semiconductor laser. It is recommended for use in a room at the following temperature: 41°F - 95°F / 5°C - 35°C

WARNING:

TO PREVENT FIRE OR SHOCK HAZARD, DO NOT EXPOSE THIS CD PLAYER TO WATER OR MOISTURE

CAUTION:

1. Handle the power supply cord carefully. Do not damage or deform; it may cause electric shock or malfunction when used. Hold plug attachment when removing from wall outlet. Do not pull on the cord.
2. To avoid electric shock, do not open the top cover when the unit is plugged in. If problems occur with the unit, call your local American Audio® dealer.
3. Do not place metal objects or spill liquid inside the CD player. Electric shock or malfunction may occur.



CAUTION

**Do not open -
Risk of electric shock**



CAUTION: TO REDUCE THE RISK OF ELECTRIC SHOCK, DO NOT REMOVE THE COVER RACK. THERE ARE NO USER SERVICEABLE PARTS INSIDE REFER SERVICE TO YOUR AUTHORIZED American Audio DEALER.



The lightning flash with an arrow triangular symbol is intended to alert the user to the presence of non insulated "dangerous voltage" within the products enclosure, and may be of sufficient magnitude to constitute a risk of electric shock.



The exclamation point triangular symbol is intended to alert the user to the presence of important operating and maintenance (servicing) instructions in the user manual accompanying the CD player.

CAUTION

TO PREVENT ELECTRIC SHOCK DO NOT USE THIS (POLARIZED) PLUG WITH AN EXTENSION CORD, RECEPTACLE OR OTHER OUTLET UNLESS THE BLADES CAN BE CAREFULLY INSERTED TO PREVENT BLADE EXPOSURE

CAUTION:

USE OF CONTROLS OR ADJUSTMENTS OTHER THAN THOSE SPECIFIED HEREIN MAY RESULT IN HAZARDOUS RADIATION EXPOSURE

THE COMPACT DISC PLAYER SHOULD NOT BE ADJUSTED OR REPAIRED BY ANYONE EXCEPT PROPERLY QUALIFIED SERVICE PERSONNEL.

NOTE:

This unit may cause interference to radio and television reception.

Please carefully read and understand the instructions in this manual thoroughly before attempting to operate this unit. These instructions contain important safety information regarding the use and maintenance of this unit. Take special care to follow all warning symbols and labels both on the unit and printed in this manual. Also, Please keep this manual with the unit, for future reference.

CAUTION: TO PREVENT ELECTRIC SHOCK DO NOT USE THIS (POLARIZED) PLUG WITH AN EXTENSION CORD, RECEPTACLE, OR OTHER TYPE OF ELECTRICAL OUTLET UNLESS THE WIDE BLADES CAN BE CAREFULLY INSERTED INTO A MATCHING WIDE SLOT.

ATTENTION: POUR PREVENIR LES CHOCS ELECTRIQUES NE PAS UTILISER CETTE FICHE POLARISEE AVEC UN PROLONGATEUR, UNE PRISE DE COURANT OU UNE AUTRE SORTIE DE COURANT, SAUF SI LES LAMES PEUVENT ETRE INSEREES A FOND SANS EN LAISSER AUCUNE PARTIE A DECOUVERT.

ELECTRICAL SAFETY PRECAUTIONS

ELECTRICAL PRECAUTIONS



The lightning flash with arrowhead symbol, within an equilateral triangle, is intended to alert the user to the presence of uninsulated "dangerous voltage" within the product's enclosure that may be of sufficient magnitude to constitute a risk of electric shock to persons.



CAUTION: TO REDUCE THE RISK OF ELECTRIC SHOCK, DO NOT REMOVE THE COVER (OR BACK). THERE ARE NO USER SERVICEABLE PARTS INSIDE. REFER SERVICE TO YOUR AUTHORIZED AMERICAN AUDIO® SERVICE TECHNICIAN.



The exclamation point within an equilateral triangle is intended to alert the user to the presence of important operating and maintenance (servicing) instructions in the literature accompanying the appliance.

IMPORTANT SAFETY INSTRUCTIONS

READ INSTRUCTIONS — All the safety and operating instructions should be read before the product is operated.

RETAIN INSTRUCTIONS — The safety and operating instructions should be retained for future reference.

HEED WARNINGS — All warnings on the product and in the operating instructions should be adhered to.

FOLLOW INSTRUCTIONS — All operating and use instructions should be followed.

CLEANING — The product should be cleaned only with a polishing cloth or a soft dry cloth. Never clean with furniture wax, benzine, insecticides or other volatile liquids since they may corrode the cabinet.

ATTACHMENTS — Do not use attachments not recommended by the product manufacturer as they may cause hazards.

WATER AND MOISTURE — Do not use this product near water — for example, near a bathtub, wash bowl, kitchen sink, or laundry tub; in a wet basement; or near a swimming pool; and the like.

ACCESSORIES — Do not place this product on an unstable cart, stand, tripod, bracket, or table. The product may fall, causing serious injury to a child or adult, and serious damage to the product. Use only with a cart, stand, tripod, bracket, or table recommended by the manufacturer, or sold with the product. Any mounting of the product should follow the manufacturer's instructions, and should use a mounting accessory recommended by the manufacturer.

CART — A product and cart combination should be moved with care. Quick stops, excessive force, and uneven surfaces may cause the product and cart combination to overturn.



VENTILATION — Slots and openings in the cabinet are provided for ventilation and to ensure reliable operation of the product and to protect it from overheating, and these openings must not be blocked or covered. The openings should never be blocked by placing the product on a bed, sofa, rug, or other similar surface. This product should not be placed in a built-in installation such as a bookcase or rack unless proper ventilation is provided or the manufacturer's instructions have been adhered to.

POWER SOURCES — This product should be operated only from the type of power source indicated on the marking label. If you are not sure of the type of power supply to your home, consult your product dealer or local power company.

LOCATION — The appliance should be installed in a stable location.

NONUSE PERIODS — The power cord of the appliance should be unplugged from the outlet when left unused for a long period of time.

GROUNDING OR POLARIZATION

- If this product is equipped with a polarized alternating current line plug (a plug having one blade wider than the other), it will fit into the outlet only one way. This is a safety feature. If you are unable to insert the plug fully into the outlet, try reversing the plug. If the plug should still fail to fit, contact your electrician to replace your obsolete outlet. Do not defeat the safety purpose of the polarized plug.

- If this product is equipped with a three-wire grounding type plug, a plug having a third (grounding) pin, it will only fit into a grounding type power outlet. This is a safety feature. If you are unable to insert the plug into the outlet, contact your electrician to replace your obsolete outlet. Do not defeat the safety purpose of the grounding type plug.

POWER-CORD PROTECTION - Power-supply cords should be routed so that they are not likely to be walked on or pinched by items placed upon or against them, paying particular attention to cords at plugs, convenience receptacles, and the point where they exit from the product.

OUTDOOR ANTENNA GROUNDING — If an outside antenna or cable system is connected to the product, be sure the antenna or cable system is grounded so as to provide some protection against voltage surges and built-up static charges. Article 810 of the National Electrical Code, ANSI/NFPA 70, provides information with regard to proper grounding of the mast and supporting structure, grounding of the lead-in wire to an antenna discharge unit, size of grounding conductors, location of antenna-discharge unit, connection to grounding electrodes, and requirements for the grounding electrode. See Figure A.

LIGHTNING — For added protection for this product during a lightning storm, or when it is left unattended and unused for long periods of time, unplug it from the wall outlet and disconnect the antenna or cable system. This will prevent damage to the product due to lightning and power-line surges.

POWER LINES — An outside antenna system should not be located in the vicinity of overhead power lines or other electric light or power circuits, or where it can fall into such power lines or circuits. When installing an outside antenna system, extreme care should be taken to keep from touching such power lines or circuits as contact with them might be fatal.

OVERLOADING — Do not overload wall outlets, extension cords, or integral convenience receptacles as this can result in a risk of fire or electric shock.

OBJECT AND LIQUID ENTRY - Never push objects of any kind into this product through openings as they may touch dangerous voltage points or short-out parts that could result in a fire or electric shock. Never spill liquid of any kind on the product.

SERVICING — Do not attempt to service this product yourself as opening or removing covers may expose you to dangerous voltage or other hazards. Refer all servicing to qualified service personnel.

DAMAGE REQUIRING SERVICE - Unplug this product from the wall outlet and refer servicing to qualified service personnel under the following conditions:

- When the power-supply cord or plug is damaged.
- If liquid has been spilled, or objects have fallen into the product.
- If the product has been exposed to rain or water.
- If the product does not operate normally by following the operating instructions. Adjust only those controls that are covered by the operating instructions as an improper adjustment of other controls may result in damage and will often require extensive work by a qualified technician to restore the product to its normal operation.
- If the product has been dropped or damaged in any way.
- When the product exhibits a distinct change in performance — this indicates a need for service.

REPLACEMENT PARTS — When replacement parts are required, be sure the service technician has used replacement parts specified by the manufacturer or have the same characteristics as the original part. Unauthorized substitutions may result in fire, electric shock, or other hazards.

SAFETY CHECK - Upon completion of any service or repairs to this product, ask the service technician to perform safety checks to determine that the product is in proper operating condition.

WALL OR CEILING MOUNTING — The product should not be mounted to a wall or ceiling.

HEAT — The product should be situated away from heat sources such as radiators, heat registers, stoves, or other products (including amplifiers) that produce heat.

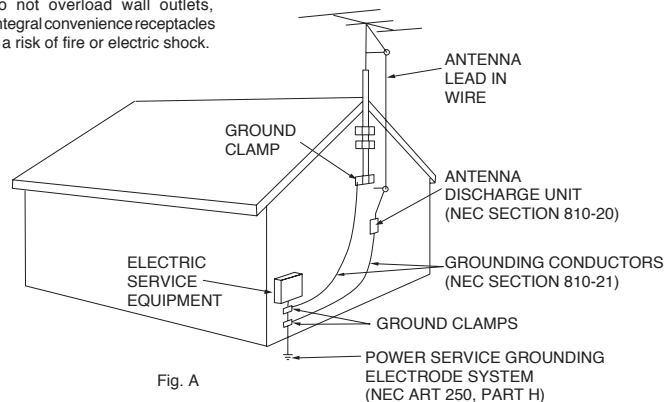

Fig. A

NEC — NATIONAL ELECTRICAL CODE

SAFETY INSTRUCTIONS

1. Read Instructions - All the safety and operating instructions should be read before the CD Player is operated. The safety and operating instructions should be saved for future reference.
2. Heed Warnings - All warnings on the CD Player and in the operating instructions should be adhered to.
3. Water and Moisture - The player should not be used near water - for example, near a bath tub, kitchen sink, laundry tub, in a wet basement or near a swimming pool, etc.
4. Ventilation - The CD Player should be situated so that its location or position does not interfere with its proper ventilation. For example, the CD player should not be situated on a bed, sofa, rug, or similar surface that may block the ventilation openings; or, placed in a built-in installation, such as a bookcase or cabinet that may impede the flow of air through the ventilation openings.
5. Heat - The CD player should be situated away from heat sources such as radiators, heat registers, stoves, or other appliances (including amplifiers) that produce heat.
6. Power Sources - The CD player should be connected to a power supply only of the type described in the operating instructions or as marked on the CD Player.
7. Servicing - The user should not attempt to service the CD Player beyond that described in the operating instructions. All other servicing should be referred to qualified service personnel. The Player should be serviced by qualified service personnel when:
 - A. The power-supply cord or the plug has been damaged.
 - B. Objects have fallen, or liquid has been spilled into the CD Player.
 - C. The CD Player has been exposed to rain or water.
 - D. The CD Player does not appear to operate normally or exhibits a marked change in performance.

Line Voltage Selection

Because power supplies vary from location to location we have incorporated a selectable power supply.

- The desired voltage may be set with the VOLTAGE SELECTOR switch on the rear panel (using a flat head screw driver).
- Do not force the VOLTAGE SELECTOR switch as this may cause damage
- If the VOLTAGE SELECTOR switch does not move smoothly, please contact a qualified service technician.

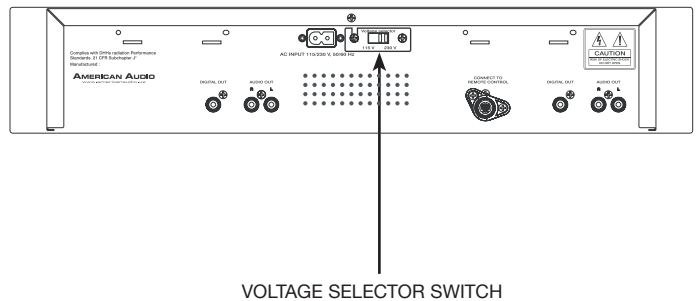

The serial and model number for this unit is located on the rear panel. Please write down the numbers here and retain for future reference.

Model No. _____

Serial No. _____

Purchase Notes:

Date of Purchase _____

Dealer Name _____

Dealer Address _____

Dealer Phone _____

UNPACKING

Every MCD-710™ has been thoroughly tested and has been shipped in perfect operating condition. Carefully check the shipping carton for damage that may have occurred during shipping. If the carton appears to be damaged, carefully inspect your CD player for any damage and be sure all equipment necessary to operate the CD player has arrived intact. In the event damage has been found or parts are missing, please contact our toll free customer support number for further instructions. Please do not return the CD player to your dealer without first contacting customer support.

INTRODUCTION

Introduction:

Congratulations and thank you for purchasing the American Audio® MCD-710™ CD player. This CD player is a representation of American Audio's continuing commitment to produce the best and highest quality audio products possible at an affordable price. Please read and understand this manual completely before attempting to operate your new CD player. This booklet contains important information concerning the proper and safe operation of your new CD player.

Customer Support:

American Audio® provides a toll free customer support line, to provide set up help and answer any question should you encounter problems during your initial set up or operation. You may also visit us on the web at www.americanaudio.us for any comments or suggestions. Service Hours are Monday through Friday 9:00 a.m. to 5:30 p.m. Pacific Standard Time.

Voice: (800) 322-6337
Fax: (323) 582-2610
E-mail: support@americanaudio.us

To purchase parts online visit <http://parts.americandj.com>

Caution! There are no user serviceable parts inside this CD player. Do not attempt any repairs yourself, without being instructed to do so by an authorized American Audio service technician. Doing so will void your manufacturer's warranty. In the unlikely event your CD player may require service, please contact American Audio® customer support.

Do not discard the packing carton in the trash. Please recycle when ever possible.

SET-UP PRECAUTIONS

Please be sure to make any connections before plugging the CD player in to an electrical outlet. All fader and volume controls should be set to zero or minimum position, before the CD player is switched on. If the CD player has been exposed to drastic temperature fluctuation (e.g. after transportation), do not switch on the CD player immediately. The arising condensation of water might damage your device. Leave the device switched off until it has reached room temperature.

Operating Determinations:

- When installing this CD player, please make sure that the device is not exposed or will not be exposed to extreme heat, moisture or dust!
- Do not operate the CD player in extremely hot (more than 30°/100°F) or extremely cold (less than 5°C/40°F) surroundings.
- Keep the unit out of direct sunlight and away from heaters.
- Operate the CD player only after becoming familiar with its' functions. Do not permit operation by persons not qualified for operating the unit. Most damages are the result of unprofessional operation.

MAIN FEATURES

- 8 times over sampling 1 bit D/A converter
- Auto cue
- 1/75th second frame search
- 10 Sec. Digital Anti-Shock
- Real time cue (“Cue on the Fly”)
- 4 different speed scan (4 Forward/ 4 Reverse)
- Digital RCA coaxial output
- Bright Large Digital Screen
- Fader “Q” Start Control **(a)**
- Seamless Loop (uninterrupted loop playback)
- Jog Wheel Pitch Bend
- Memory Backup **(c)**
- Adjustable Pitch Percentages: +/-4%, +/-8%, +/-16% or +/-100% (+/-100% can only be done with actual music cds.)
- Instant Start within 10 ms (sound is produced immediately when the PLAY button is pressed)
- Tempo Lock
- Mp3 Track Listings
- Plays Mp3 and CD discs
- Folder Search
- Flash Start Function **(d)**
- Sleep Mode **(f)**
- Bop Effect **(e)**
- Pitch display
- Flip-Flop **(b)**
- Selectable Single or Continuous Play
- Auto BPM

.....

(a) FADER “Q” START CONTROL: This feature is used in conjunction with most American Audio® and American DJ® audio mixers that also feature “Fader Q-Start” control. Connect your MCD-710 as described in the set-up section of this manual. After set up is completed load CDs into both players. By moving the mixer’s crossfader from left to right you can start and pause the MCD-710™ playback functions. For Example, if the mixer’s crossfader is all the way to the left (player one is playing and player two is in cue or pause mode), and you move the fader at least 20% to the right, player two (2) will begin to play and player one (1) will return to cue mode. When the crossfader is to the right, and you move it 20% to the left, player one (1) will begin to play and player two (2) will return to its’ cue point. You can create great effects similar to scratching with this feature. After storing cue points on each side of the CD player, different songs or loops may quickly be recalled by moving the mixer crossfader back and forth. New cue points can be easily selected on the MCD-710™ player (see *setting cue points page 17*). “Q” Start control is easy to use and mastering this feature will help you create amazing effects with your music.

(b) FLIP-FLOP: This feature is used in conjunction with American Audio® mixers that also feature Fader “Q” Start. For FLIP-FLOP results you must use both sides of the MCD-710™. Connect your MCD-710 as described in the set-up section of this manual. This feature will start the next player once one (1) player has ended. For example, if player one (1) is playing a disc and it ends, player two (2) will instantly begin to play. You may set FLIP-FLOP to play track to track or disc to disc. For more information on this feature, see FLIP-FLOP™ on page 27.

(c) MEMORY BACKUP: The MCD-710™ has a five (5) year memory back-up, that will save your setting in case the power supply is accidentally disconnected. MCD-710™ will remember your last setting (SGL, and CTN) even if you disconnect your main power. See memory on page 21.

(d) FLASH START FUNCTION: This feature is used in conjunction with most American Audio® and American DJ® audio mixers that also feature “Fader Q Start” control. This function work similar to the Fader "Q" Start Control described above. In this case the crossfader is used to start and stop any loop that is stored in the players memory.

(e) BOP EFFECT: The Bop Effect button serves two features. First, it is a stutter effect, creating a sound similar to a loopr. Second, it will return to the last Cue point in memory instantly. This will allow you to create great effects. To create the BOP Effect, see BOP Effect on page 25.

(f) SLEEP MODE: The MCD-710's laser and pick-up assembly will power down after 15 minutes of inactivity (when in pause or cue mode). This will lengthen the life of your motor drive and laser. To initialize the player, just press the cue or play buttons.

SET-UP

1. Checking the Contents

Be sure your MCD-710™ was shipped with the following:

- 1) MCD-710™ Transportation Unit
- 2) MCD-710™ Controller Unit
- 3) Operating Instructions (This Booklet)
- 4) One (1) Control Cable
- 5) Two (2) "Q-Start" 1/8" mini plug.
- 6) Two (2) Sets of Stereo RCA Cables
- 7) Warranty card.

2. Installing the Units

- 1) Place your unit on a flat surface or mount it in a secure rack mount case.
- 2) Be sure the player is mounted in a well ventilated area where it will not be exposed to direct sunlight, high temperatures, or high humidity.
- 3) Try to place the unit as far as possible from TVs and tuners, as the unit may cause undesirable interference.

3. Connections

- 1) Be sure main power is connected last to prevent any electrical damage.
- 2) **AUDIO CONNECTIONS:** Use the included RCA cable to connect the MCD-710™ outputs to the line inputs of a mixer. Never connect a CD player's output to a mixers "phono" inputs.
- 3) **CONTROL JACK CONNECTIONS:** Use the supplied 1/8" mono mini plug cable to connect your MCD-710™ to a mini jack connection (A or B) on a compatible American Audio® or American DJ® "Fader Q Start" mixer. (This will enable the Fader "Q" Start function - See "Q" start control page 7).
- 4) Connect the supplied D-Plug control cables from the transport unit to the controlling unit. Be sure to transport drive one is connected to controlling unit one and transport drive two is connected to controlling drive two.

CAUTION:

- **Be sure to use the supplied mono 1/8" control cables. Using other types of cable may result in unit damage**
- **To avoid sever damage to the unit, be sure the power is off when making connections to the unit.**

Installation Note:

The player will work normally when the main unit is mounted with the front panel within 15 degrees of the vertical plane. If the unit is tilted excessively, discs may not be loaded or unloaded properly. **(Figure 1)**

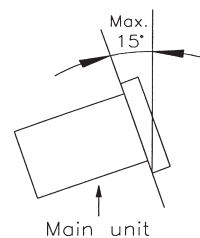

Figure 1

GENERAL FUNCTIONS AND CONTROLS

Figure 2

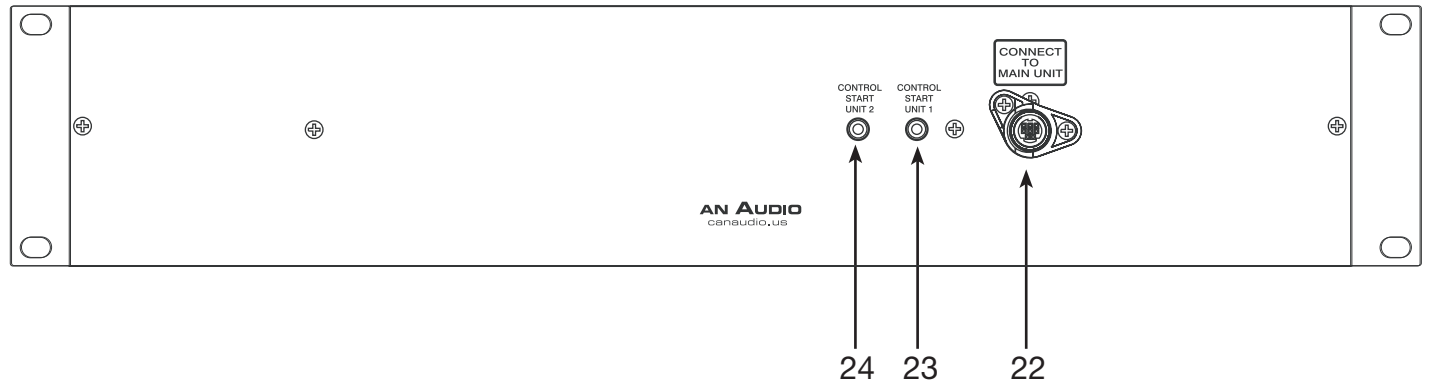
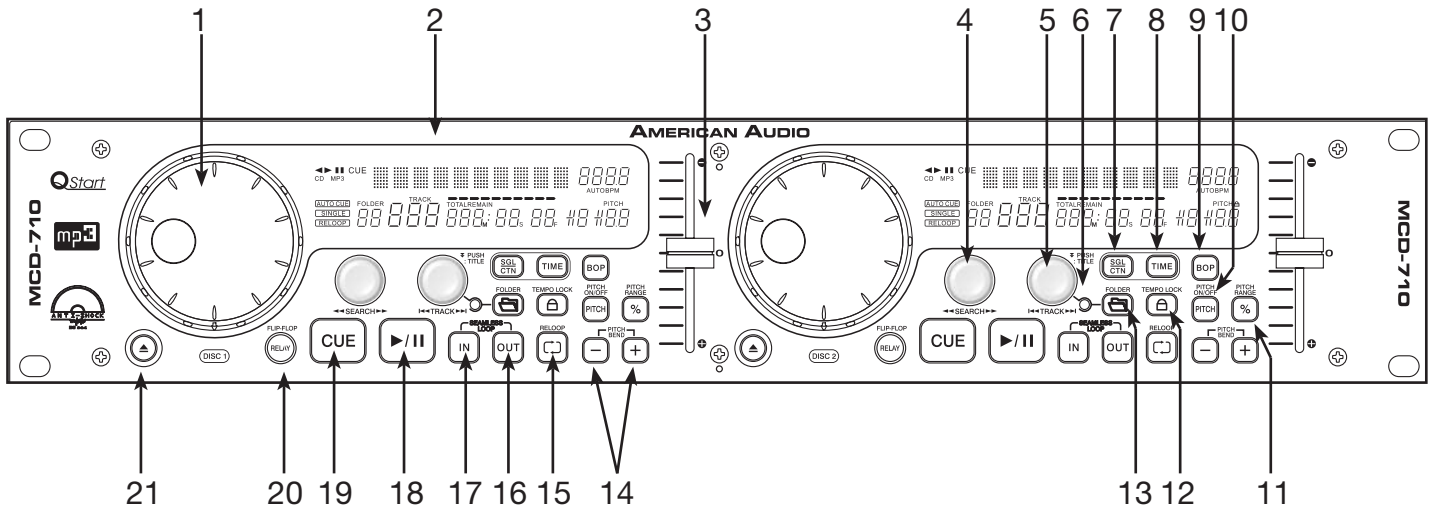

Figure 3

A. CONTROLLER UNIT (FIGURE 3)

1. JOG WHEEL -This wheel has three functions:

- A.** The wheel works as a pitch bend during Playback. Turning the wheel clockwise can increase the pitch percentage up to 100%,and turning the wheel in the counter-clockwise direction can decrease the pitch percentage down to -100%. The pitch bend will be determined on how long you turn the jog wheel continuously.
- B.** The jog wheel will act as a slow frame search control when the unit is in pause or cue mode allowing you to set a specific cue point or find a particular starting point.
- C.** The jog wheel is also used to edit your seamless loop. See page 19 for more details.

2. VFD DISPLAY - This high quality VFD display indicates all the functions, as they are occurring.

This display is viewable at several comfortable angles (see page 8). The display ICONS will be explained on page 14.

3. PITCH SLIDER - This slider is used to adjust the playback pitch percentage. The slider is a set adjustment and will remain set until the pitch slider is moved or the pitch function has been turned off. This adjustment can be made with or without a disc in the drive. The pitch adjustment will remain even if a disc has been remove and will reflect on any other disc loaded into the player. That is to say, if you set a +2% pitch on one disc, remove that disc and insert another, that disc too will have a +2% pitch. The amount of pitch being applied will be displayed in the VFD (2).

4. SEARCH KNOB -The search function has four forward and four reverse speed positions

GENERAL FUNCTIONS AND CONTROLS (Cont.)

allowing you to quickly scan through tracks. The more you turn the wheel in either direction, the faster your search.

5. TRACK/FOLDER KNOB - This knob is used to scroll backward and forward through tracks. Pushing this knob and turning it at the same time will let you scroll through the folders found on a Mp3 disc. Also, when you press it once it will toggle between the track name and the album name on an Mp3 disc.

6. FOLDER L.E.D. - This L.E.D. indicates that the FOLDER BUTTON is activated.

7. SGL/CTN - This function allows you to choose between single track play or continuous track play (all tracks in order). This function also operates in FLIP FLOP mode. This button will also allow you to turn the Auto Cue function on and off. See page 14 for this function.

8. TIME BUTTON - The TIME button will switch the time value described in the *TIME METER* between ELAPSED PLAYING TIME, and TRACK REMAINING TIME. This button will also allow you to enter the firmware, sleep mode, and Memory clear menus. See page 20 for this menu function.

9. BOP BUTTON - During play mode, pressing the BOP button will instantly return play to the last set cue point without interruption of music.

10. PITCH ON/OFF BUTTON - This button is used to turn the *PITCH SLIDER (3)* function on and off. This button will also change the pitch percentage the *PITCH SLIDER (3)* will react to. The pitch percentage can be changed between 4%, 8%, and 16%. ***It can also be changed to 100%, but only when a cd is loaded, not an Mp3 disc.*** 4% will allow the least amount of pitch manipulation and 16% or 100% (depending on the type of disc loaded) will allow the most amount of pitch manipulation. To adjust to the different values please see page 23. Note when the button L.E.D. is not glowing the Pitch Function is not activated.

11. PITCH PERCENTAGE SELECTOR- Choose from pitch percentages of 4%, 8%, 16%, and

100%. See page 23 for more details.

12. TEMPO LOCK FUNCTION - This button activates the TEMPO LOCK function. This function allows you to use the *PITCH SLIDER* to speed up or slow down playback speed without altering the tonal pitch of the track. When this function is not engaged the original tonal pitch of the track will be altered giving you the "chip-munk" effect when a track is played at a high rate of speed, or the "James Earl Jones" effect when a track is slowed to much. To turn this function off, press and hold down this button for at least 1 second and then release.

13. FOLDER BUTTON - This button is used to toggle between folders and tracks. Press this button to show the folder that is playing in the VFD. This button is only for Mp3 discs.

14. PITCH BEND BUTTONS -

(-) PITCH BEND BUTTON - The (-) pitch bend function creates a momentary "Slow Down" in the CD's BPM's (Beats per minute) while it is playing. This will allow you to match the beats between two playing CD's or other playing music source. Remember, this is a momentary function. When you remove your finger from the pitch button, the BPM's will automatically return to *PITCH SLIDERS (3)* pitch value Holding down this button will give a maximum of -16% or -100% pitch (depending on the type of disc loaded). Use this function to slow to another playing music source. Be sure to notice that this function is a momentary pitch adjustment, for a more precise adjustment use the *PITCH SLIDER (3)* to match the BPM's with another playing music source.

(+) PITCH BEND BUTTON - The (+) pitch bend function creates a momentary "BUMP" in the CD's BPM's (Beats per minute) while it is playing. This will allow you to match the beats between two playing CD's or any other music source. Remember, this is a momentary function. When you remove your finger from this button, the BPM's will automatically return to *PITCH SLIDERS (3)* selected pitch. Holding down this button will give a maximum of +16% or (+100% for CD) pitch.

GENERAL FUNCTIONS AND CONTROLS (Cont.)

15. RELOOP BUTTON - If a SEAMLESS LOOP has been made (see setting a SEAMLESS LOOP on page 19), but the CD Player is not actively in SEAMLESS LOOP mode (a loop is not playing), pressing the RELOOP BUTTON will instantly reactivate the SEAMLESS LOOP mode. To exit loop, press the *OUT BUTTON* (16). LOOP and RELOOP will appear in the *VFD DISPLAY* (2) when the RELOOP function is available.

16. OUT BUTTON - This button is used to set the ending point of a loop. A loop is started by pressing the *IN BUTTON* (17), pressing the OUT BUTTON set the loop ending point. The loop will continue to play until the OUT BUTTON is pressed once again.

17. IN BUTTON - "CUE ON THE FLY" - This function allows you to set a CUE POINT (see CUE POINT page 17) without music interruption ("on the fly"). This button also sets the starting point of a seamless loop (see SEAMLESS LOOP).

18. PLAY/PAUSE BUTTON - Each press of the PLAY/PAUSE BUTTON causes the operation to change from play to pause or from pause to play. While in play mode the blue play L.E.D. will glow, and while in pause mode the blue play L.E.D. will flash.

19. CUE - Pressing the **CUE** button during playback immediately pauses playback and returns the track to the last set cue point (see setting a CUE POINT, page 17). The green CUE L.E.D. will glow when the unit is in cue mode The L.E.D. will also flash every time a new CUE POINT is set. The CUE button can be held down to momentarily play the CD. When you release the CUE button it instantly returns to the CUE POINT. You can also tap the CUE button to create a BOP EFFECT (for definition of BOP EFFECT, see page 25).

20. RELAY BUTTON - This button activates the FLIP-FLOP™ function.

21. EJECT FUNCTION - Pressing this will eject the CD. The eject function will only when the unit is in cue mode, this is to prevent accidentally ejecting the disc when in play mode.

B. REMOTE CONTROL - REAR

22. REMOTE JACK - Connect the supplied 8 pin din cable from this jack to the player's remote connector. This will allow you to control the functions of the player .

23. CHANNEL 1 CONTROLLER JACK - Connect the supplied mini-plug from the CUE jack on the rear of your CD unit to the CONTROL out jack of a compatible American Audio® or American DJ® mixer. This will enable the CD "Q-Start" function. This feature is only available on American Audio® "Q" series mixers.

24. CHANNEL 2 CONTROLLER JACK - Connect the supplied mini-plug from the CUE jack on the rear of your CD unit to the CONTROL out jack of a compatible American Audio® or American DJ® mixer. This will enable the CD "Q-Start" function. This feature is only available on American Audio® or American DJ® "Q" series mixers.

GENERAL FUNCTIONS AND CONTROLS (Cont.)

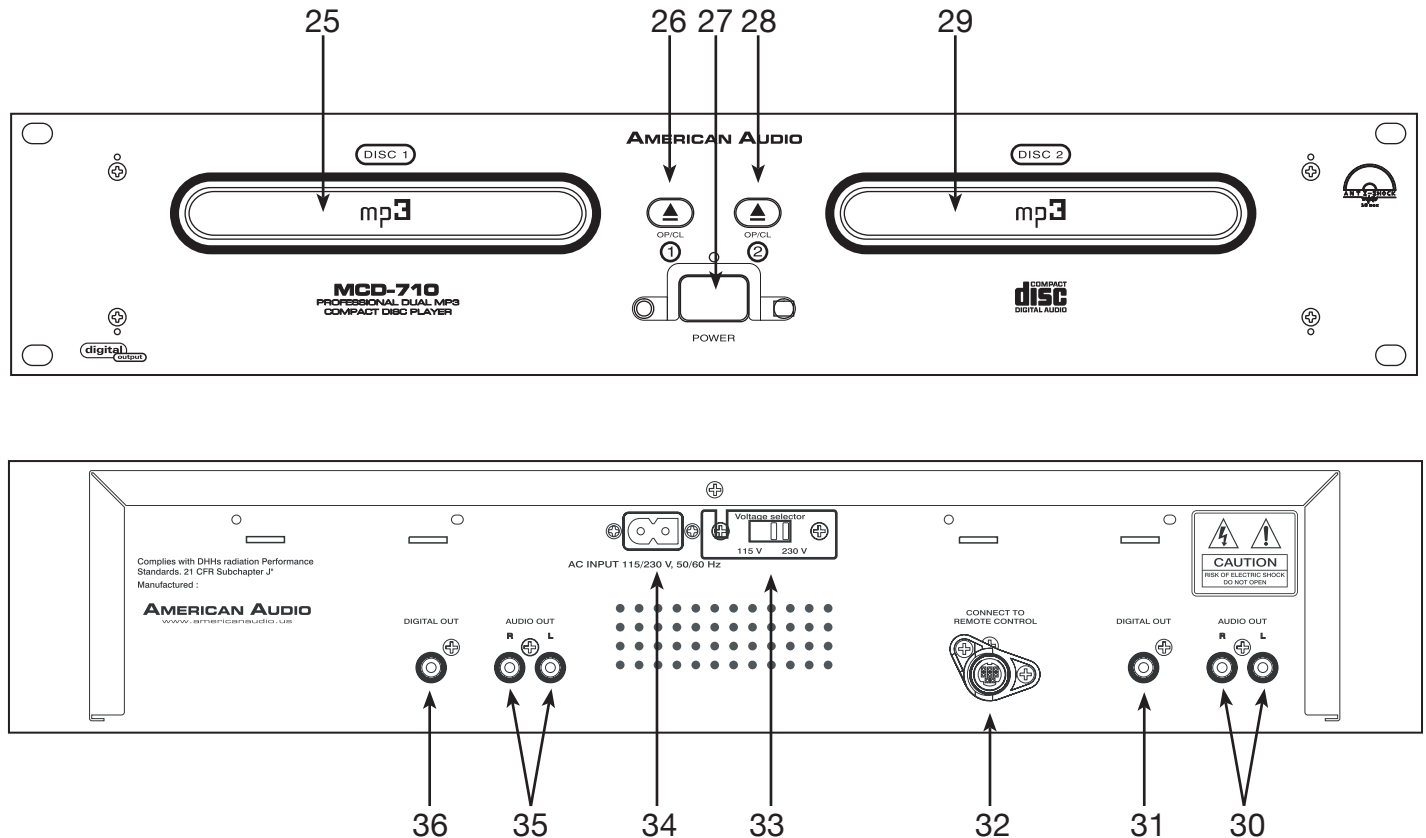

Figure 4

B. TRANSPORT UNIT (FIGURE 4)

25. DRIVE 1 TRANSPORT TRAY - This tray is used to load and unload a compact disc in to the drive 1 mechanism. The tray is opened and closed by pressing the DRIVE 1 OPEN/CLOSE BUTTON (26). Never attempt to force the to transport tray open or close when the power is turned off.

26. DRIVE 1 OPEN/CLOSE (Transport Tray Open/Close) - This button is used to open and close the drive 1 transport tray. NOTE: When a disc is already loaded in the transport tray, the tray will not open unless the unit is in pause or cue mode.

27. POWER SWITCH - This switch is used to control the unit's main power. A blue L.E.D. directly above the power switch will glow to indicate main power is active.

28. DRIVE 2 OPEN/CLOSE (Transport Tray Open/Close) - This button is used to open and close the drive 2 transport tray. NOTE: When a disc is already loaded in the transport tray, the tray will not open unless the unit is in pause or cue mode.

29. DRIVE 2 TRANSPORT TRAY - This tray is used to load and unload a compact disc in to the drive 2 mechanism. The tray is opened and closed by pressing the DRIVE 2 OPEN/CLOSE BUTTON (28). Never attempt to force the transport tray to open or close when the power is turned off.

30. DRIVE 1 AUDIO OUT R & L - These jacks send a left and right analog mono output signal. Use these jacks to send standard audio to a mixer or receiver. The red colored jack represents the right channel output and white jack repre-

GENERAL FUNCTIONS AND CONTROLS (Cont.)

sents the left channels output.

31. DRIVE 1 DIGITAL OUT - This jack sends a digital stereo out signal. Use this connection to create near perfect copies of your disc to a Mini disc, CD-R, or any other recording device with a digital input.

32. REMOTE JACK - Connect the supplied 8 pin din cable from this jack to the remote control's channel 1 remote connector. This will allow you to control the player functions with the remote unit.

33. VOLTAGE SELECTOR - Because power supplies vary from location to location a voltage selector switch has been incorporated in the unit's design. This switch can select a voltage input of 120V or 220V to accommodate the two major power source. Always be sure to disconnect the power plug before changing the voltage.

***Only dual voltage models have this switch.**

34. POWER CONNECTOR - This is the main power connection. Only use the supplied polar-

ized power cord. Use of any other power may result in sever damage to the unit. Be sure the local power matches the unit's required power.

35. DRIVE 2 AUDIO OUT R & L - These jacks send a left and right analog mono output signal. Use these jacks to send standard audio to a mixer or receiver. The red colored jack represents the right channel output and white jack represents the left channels output.

36. DRIVE 2 DIGITAL OUT - This jack sends a digital stereo out signal. Use this connection to create near perfect copies of your disc to a Mini disc, CD-R, or any other recording device with a digital input.

GENERAL FUNCTIONS AND CONTROLS (Cont.)

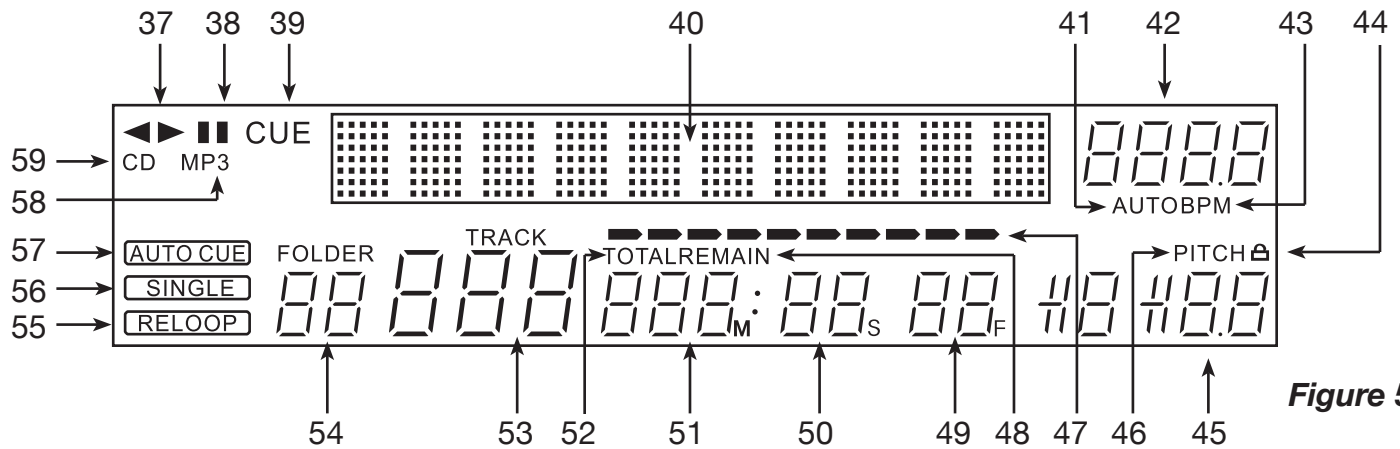

Figure 5

D. VFD DISPLAY PANEL (FIGURE 5)

37. PLAY INDICATOR - The "PLAY" indicator will glow when the unit is in play mode.

38. PAUSE INDICATOR - This indicator will glow when the drive is in pause mode.

39. CUE INDICATOR - This indicator will glow when the unit is in CUE or mode and will flash every time a new CUE POINT is set.

40. CHARACTER DISPLAY - This will display the name of the track, artist, and album when a Mp3 disc is loaded.

41. AUTO BPM - This will indicate that the AUTO BPM counter is active.

42. BPM METER - This meter will display the BPM's of the current track.

43. BPM INDICATOR - Indicator will light up whatever is being displayed.

44. TEMPO LOCK - This will indicate the Tempo Lock function is active.

45. PITCH METER - This meter will display the pitch percentage applied by the *PITCH SLIDER* (3).

46. PITCH INDICATOR - Indicator will light up when the Pitch is activated.

47. TIME BAR INDICATOR - This bar gives a visual approximation of a track's or disc's remaining time. This bar will begin to flash when a CD is ending or a track if the unit is in "SINGLE" mode.

48. REMAIN INDICATOR - When "REMAIN" is indicated in the *VFD DISPLAY* (2) the *TIME DESCRIBED* (49, 50, & 51) in the *VFD* will define the current track's remaining time.

49, 50, 51. TIME DISPLAY - These indicators detail the Minutes, Seconds, and Frames. The meter will display either the elapsed time, or remaining time of a track. The time displayed in the meter will directly reflect the time indicator.

52. TOTAL/REMAIN INDICATOR - When "TOTAL" and "REMAIN" are indicated in the *VFD DISPLAY* (2) the *TIME DESCRIBED* (49, 50, & 51) in the *VFD* (2) will define the total disc remaining time.

53. TRACK INDICATOR - This 3-digit indicator visually details the current track cued or playing.

54. FOLDER INDICATOR - This will indicate which folder you are in when a Mp3 disc is loaded. The Folder Button must be activated to see which Folder you are in. If not you will only see the Track Number. See page 26 for more details.

55. RELOOP INDICATOR - Appears when RELOOP is engaged or ready to be engaged.

56. SINGLE INDICATOR - This indicates that the CD drive is in single play mode, the track will play once and return to CUE mode. If the single indicator is not on the unit is in continuous mode. In continuous mode the drive will play all the remaining tracks on the disc. Once the remaining tracks have ended the unit will return to cue mode.

57. AUTO CUE - This will indicate if the Auto Cue is on or off. Press and hold the *SGL/CTN* (7) for 1 sec. to turn the Auto Cue function on and off.

58. MP3 INDICATOR - This will indicate that a Mp3 disc is loaded in the drive.

59. CD INDICATOR - This will indicate that a CD is loaded in the drive.

BASIC OPERATIONS

1. LOADING/EJECTING DISCS

The MCD-710™ can only play 3 and 5 inch CDs. Odd shaped, and oval CDs are not compatible. When loading a CD into the transport tray, always hold the disc by its edge (see Figure 6). Load the disc label side up and place it in the disc tray. Never touch the signal surface (the glossy side). To remove a disc from the tray press the *EJECT BUTTON* (21), see Figure 7.

CAUTION:

- **NEVER** attempt to load any other objects besides a 3" or 5" CD.
- **NEVER** attempt to load more than one disc at a time. Doing so may result in severe damage to your unit.
- **NEVER** force the transport tray open or closed when the power is off, as this may result in malfunction and damage the transport system.

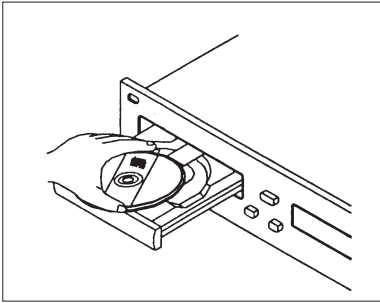

Figure 6: When loading a disc always hold the disc by its edges and load the disc label side up.

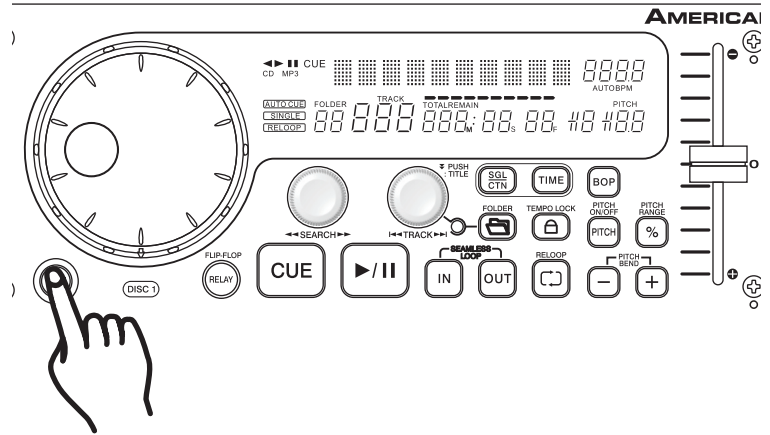

Figure 7: Hold down the Eject Button to remove a disc.

2. SELECTING TRACKS

Select a desired track by using the *TRACK KNOB* (5). Turning the *TRACK KNOB* (5) once will select either the next higher or lower track, depending on which way you turn it. If you are using the *TRACK KNOB* (5) to select a new track during playback (a track is already in play mode) the new track you selected will immediately begin playback as soon as the search operation is completed.

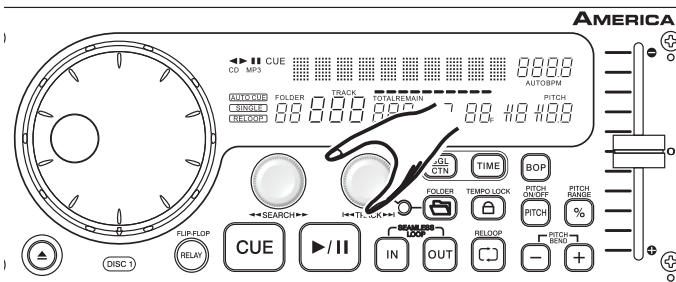

Figure 8: Turning the track knob counterclockwise will take you to the previous track.

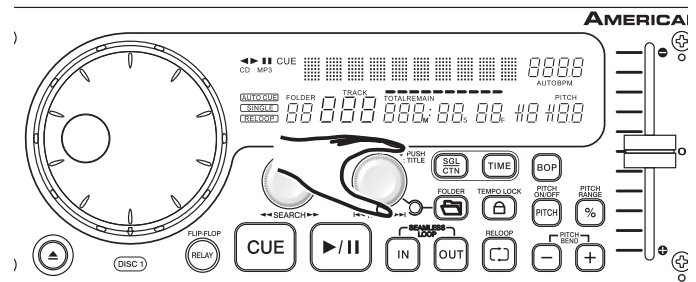

Figure 9: Turning the track knob clockwise will take you to the next track.

BASIC OPERATIONS (CONT.)

3. STARTING PLAYBACK - Figure 10

Insert an audio CD as described on page 15 (LOADING/EJECTING DISCS). Pressing the **PLAY/PAUSE BUTTON (18)** with an audio CD loaded will immediately start playback. The **PLAY (37)** indicator will glow as soon as playback begins. The point at which playback starts (cue point) will automatically be stored in the memory as the cue point. The unit will return to this cue point (the point at which playback started) when the **CUE BUTTON (19)** is pressed and released.

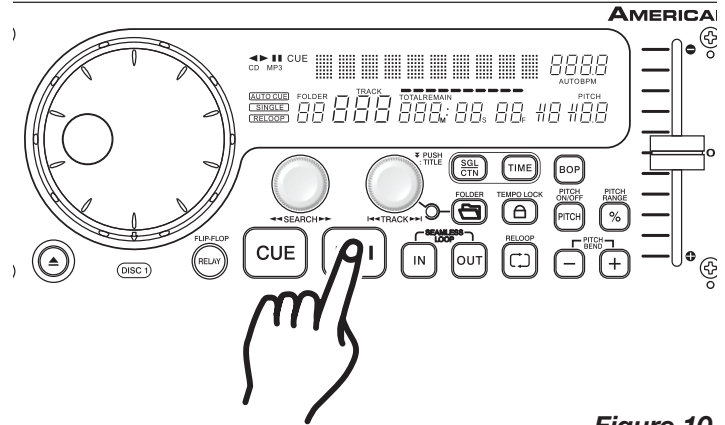

Figure 10

4. AUTO CUE

This function will automatically set a cue point to the first audio source when a CD is loaded. The first set cue point will always be the beginning of track 1. If a new track is selected before the **PLAY BUTTON (18)** is pressed, a new CUE POINT will be set to reflect the new starting point.

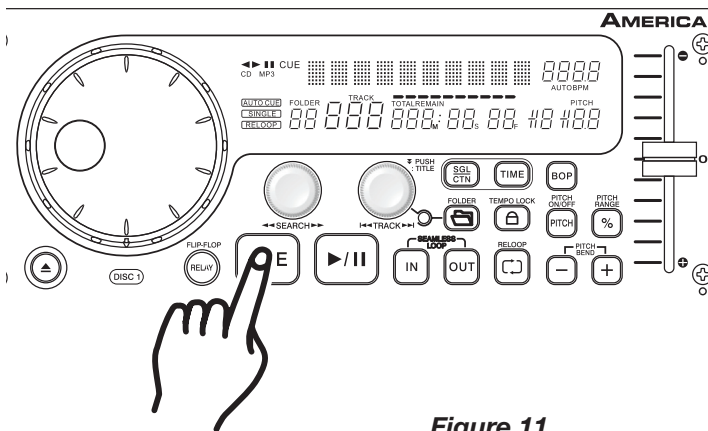

Figure 11

6. PAUSING - Figure 10

This function pauses playback at the exact same point the **PLAY/PAUSE BUTTON (18)** was pressed. Pressing the **PLAY/PAUSE BUTTON (18)** will switch between play and pause modes. When the unit is in pause mode the **PAUSE INDICATOR (38)** in the **VFD DISPLAY (2)** and the green **PLAY/PAUSE BUTTON (18)** L.E.D. will begin to flash repeatedly.

5. STOPPING PLAYBACK - Figures 10 & 11

Stopping playback will not stop the drive mechanism, but merely pause or cue the track, this function allows the unit to begin play instantly. The drive mechanism will only stop if a disc is ejected or the unit has gone in to sleep mode. There are two ways to stop (pause) playback:

- 1) Press the **PLAY/PAUSE BUTTON (18)** during playback. This will pause playback at the exact same point the **PLAY/PAUSE BUTTON (18)** was pressed.
- 2) Press the **CUE BUTTON (19)** during playback. This will pause playback and return the track to the last set cue point.

BASIC OPERATIONS (CONT.)

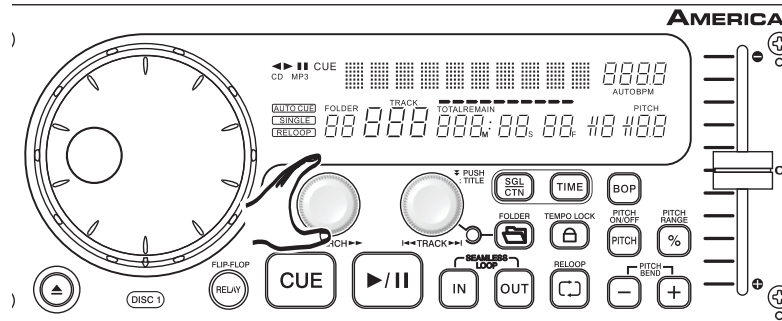

Figure 12

7. FRAME SEARCH

This feature allows you to scroll through a track frame by frame, allowing you to find and set a starting cue or loop point. To use the scroll function you must first be in Pause Mode (see section 5) or Cue Mode (see section 8). Once you are in Pause or Cue mode, turn the *SEARCH KNOB* (4) to scroll through the track (Figure 12). Turning the knob in a clockwise direction will advance the frame search and turning the knob in a counter-clockwise direction rewinds the frame search. When you use the *SEARCH KNOB* (4) the monitor (headphone level) function allows you to here what you are scrolling through. Once you reach your desired starting point you can set a cue (starting) point by pressing the *PLAY/PAUSE BUTTON* (18) as in Figure 10. Pressing the *CUE BUTTON* (19) as in Figure 11 will now return you to the point you just set.

8. SETTING a CUE POINT:

A cue point is the exact point playback will begin when the *PLAY/PAUSE BUTTON* (18) is pressed. A cue point may be created anywhere on a disc or in a track.

- 1) You may press the *IN BUTTON* (17) on the fly (while the disc is playing). This will set a *CUE POINT* without music interruption. Pressing the *CUE BUTTON* (19) will now return you to the same point that you pressed the *IN BUTTON* (17). Pressing the *CUE BUTTON* (19), or the *IN BUTTON* (17) will now return you to this exact point.

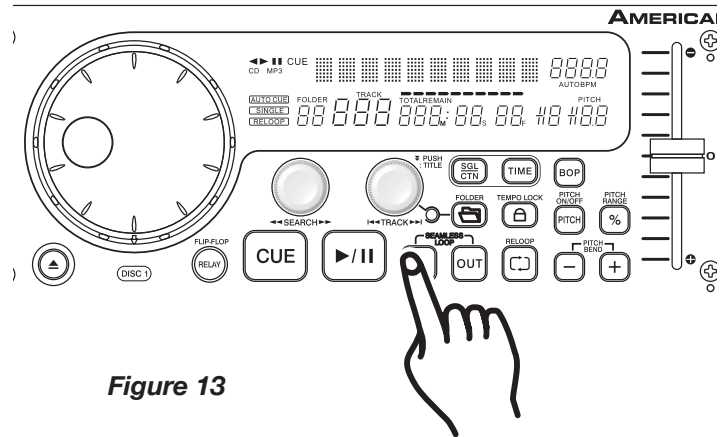

Figure 13

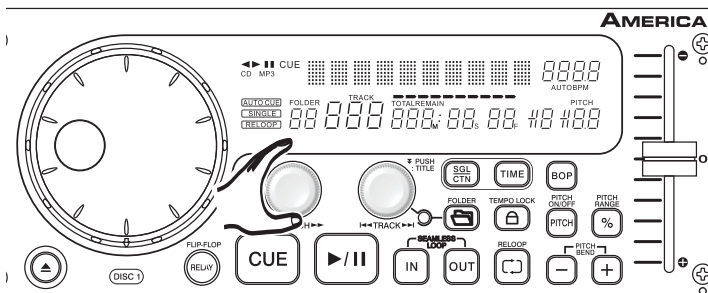

Figure 14

- 2) You may also use the *SEARCH KNOB* (4) to set a cue point. While a disc is in *PAUSE* or *CUE* mode, use the *SEARCH KNOB* (4) to scroll through a track to find your desired starting point. Once you have found your desired position press the *PLAY/PAUSE BUTTON* (18) to set your cue point. Pressing the *CUE BUTTON* (19) or the *IN BUTTON* (17) will now return you to this exact point.

BASIC OPERATIONS (CONT.)

9. CREATING AND PLAYING A SEAMLESS LOOP

A seamless loop is a sound loop that plays continuously without sound interruption. You can use this loop to create dramatic effect in your mixing. This loop has no time limit and you could actually loop the entire length of disc. You create a seamless loop between two continuous points of a disc.

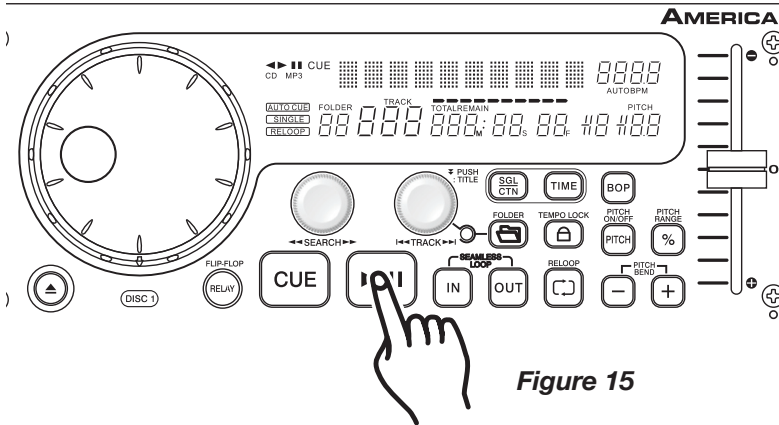

Figure 15

- 1) Press **PLAY/PAUSE BUTTON (18)** to activate playback mode.

- 2) Press the **IN BUTTON (17)**. This will set the starting point of the SEAMLESS LOOP. The **IN BUTTON (17)** L.E.D. will blink.

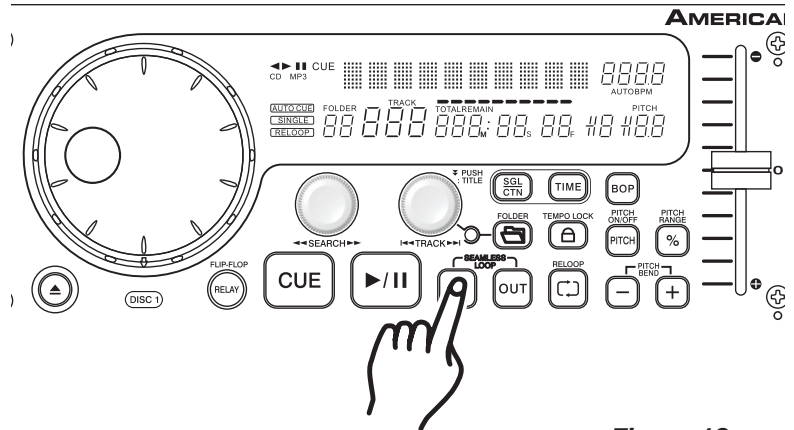

Figure 16

- 3) Press the **OUT BUTTON (16)** to set the ending point for your SEAMLESS LOOP (Figure 19). The **IN BUTTON (17)** and **OUT BUTTON (16)** L.E.D.s will immediately begin to flash rapidly, indicating the SEAMLESS LOOP mode has been activated.

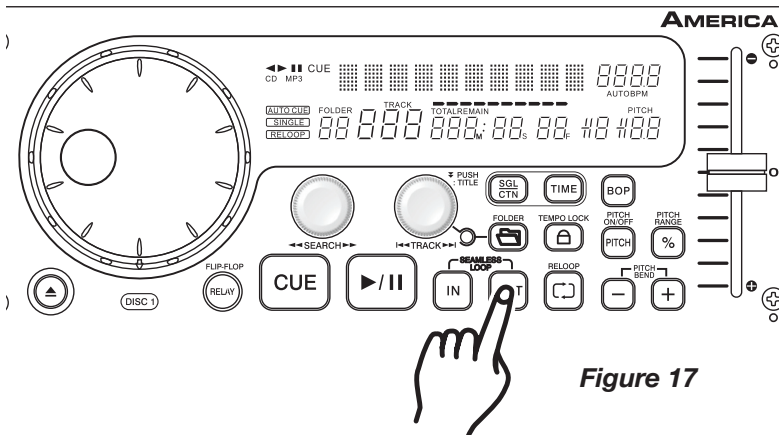

Figure 17

BASIC OPERATIONS (CONT.)

EXITING A LOOP - To exit a SEAMLESS LOOP, press the **OUT BUTTON (16)**. The **IN BUTTON (17)** and **OUT BUTTON (16)** L.E.D.s will remain on, but will stop flashing. Music playback will resume normal play (Figure 18). The **IN BUTTON (17)** and **OUT BUTTON (16)** L.E.D.s will remain on to remind you that a loop is stored in memory.

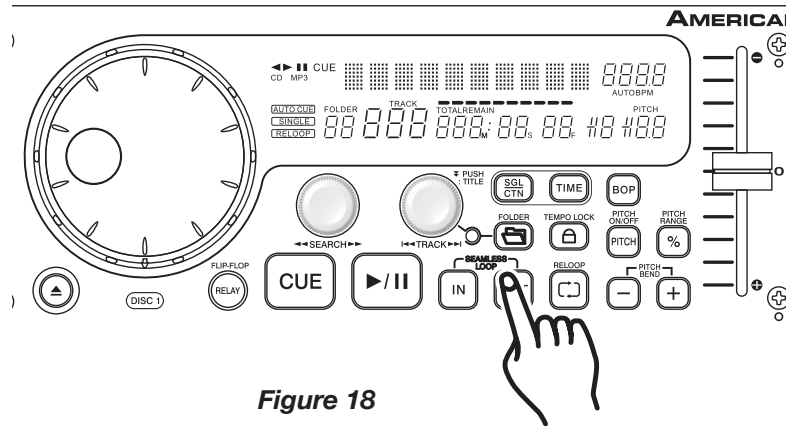

Figure 18

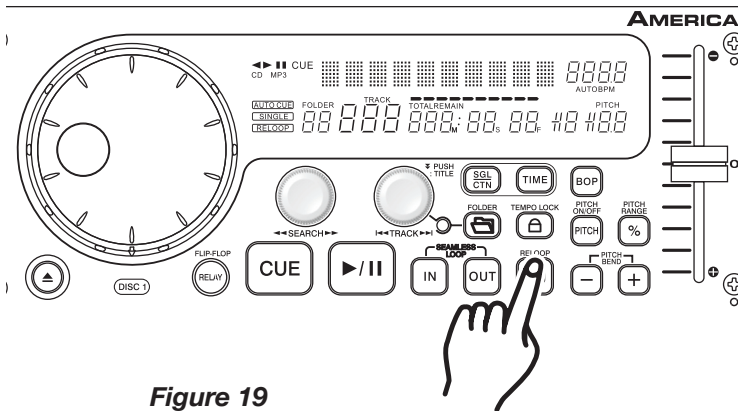

Figure 19

REPLAY LOOP - The **RELOOP (15)** function allows you to return to your stored loop at any time. The **IN BUTTON (17)** and **OUT BUTTON (16)** L.E.D.s will indicate a loop is stored in memory, and may be played at any time. To replay the loop, press the **RELOOP BUTTON (15)**. The **IN BUTTON (17)** and **OUT BUTTON (16)** L.E.D.s will again begin to flash indicating SEAMLESS LOOP mode has been activated (Figure 19) and your stored loop will immediately begin to play.

Stutter Effect: You can use your loop to create a stutter effect. When a loop is playing press the **IN BUTTON (17)** repeatedly to create this effect.

10. EDITING A LOOP:

Please Note: Only the end point of the loop may be edited. You may make your loop shorter or longer. Before you can edit your seamless loop you obviously must first have created a seamless loop to edit. If you haven't created a SEAMLESS LOOP, follow the instructions in step 9 to create a loop. If a SEAMLESS LOOP has already been created, press the **RELOOP BUTTON (15)** to activate your SEAMLESS LOOP (Figure 19) if it is not already activated. To edit your seamless loop's ending point:

Make sure the loop that you want to edit is playing. Now press and hold the **RELOOP BUTTON (15)** until the start time of your loop is displayed.

- **FOR A SHORTER LOOP:** Turn the **JOG WHEEL (1)** counter clockwise to make the loop shorter. Press the **OUT BUTTON** to set the ending point of your loop.
- **FOR LONGER LOOP:** Turn the **JOG WHEEL (1)** clockwise. Press the **OUT BUTTON** to set the ending point of your loop.

Notice: the time changes according to the setting of the time display, i.e. **REMAIN** or **ELAPSED**.

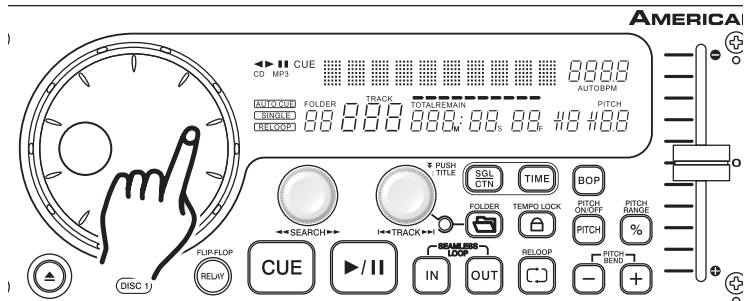

Figure 20

BASIC OPERATIONS (CONT.)

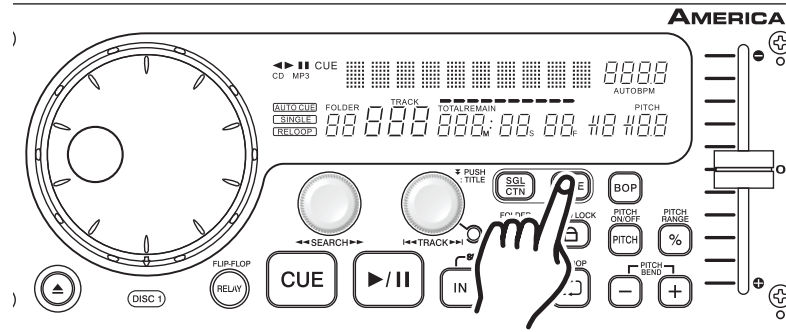

Figure 21

12. CHANGING THE TIME DISPLAY (49, 50, & 51)\TIME BAR (47):

DURING NORMAL PLAYBACK, pressing the *TIME BUTTON* (8), will change the time display information (49, 50, 51, & 47) in the *VFD* (2) see figure 21. The following is a break down of the time settings and their definitions:

- 1) **ELAPSED** - This describes the time in the VFD (49, 50, & 51) as the current TRACKS Elapsed running time. **Note: The VFD will not display "ELAPSED", or the REMAIN indicators in the VFD.**
- 2) **REMAIN** (48) - This describes the time in the VFD (49, 50, & 51) as the current TRACKS remaining running time.
- 3) **TOTAL REMAIN** (52) - This describes the time in the VFD (49, 50, & 51) as the disc total remaining running time. **NOTE: TOTAL REMAIN can only be seen or used when an actual cd is loaded, it does not work with a Mp3 cd.**

TIME BAR INDICATOR - Details the time defined in the *TIME METER* (49, 50, & 51) as a visual bar icon. As with the *TIME METER* (49, 50, & 51) this bar is also dependent on the selected time function *REMAIN* (48). This bar will begin to flash when a track is ending regardless of which time function you are in. Use the flashing bar as a visual reminder that a track is ending.

BASIC OPERATIONS (CONT.)

13. SYSTEM MEMORY AND MENU:

The MCD-710 comes with an incredible memory system. The MCD-710™ can automatically memorize customized settings for the internal menu. Press the **TIME BUTTON** for 2 sec. until "PRESET MODE" is displayed. Turn the **TRACK KNOB** to scroll through the different submenus including: A. CLOSE (Automatic Close), SLEEP TIME, DJ MODE, RESET ALL, and, FIRMWARE VERSION. **AUTOMATIC CLOSE TIME** and **SLEEP TIME** can be adjusted by stopping on the desired submenu and pushing the **TRACK KNOB**. To exit the menu settings press the **TIME BUTTON**.

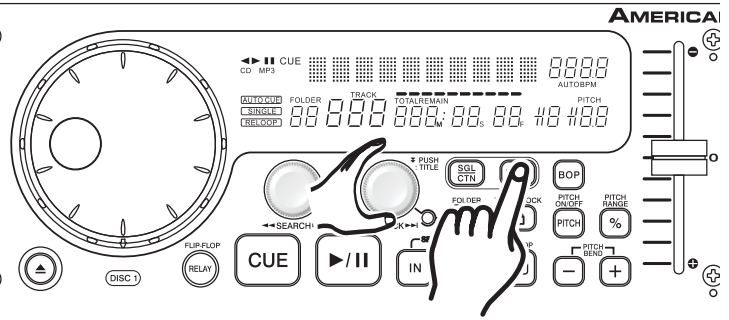

Figure 22

14. DJ MODE:

When DJ MODE is "ON", you must press the **TIME BUTTON** before you can open the CD tray. When DJ MODE is "OFF", you can press the **OPEN/CLOSE BUTTON** at anytime to open the CD tray.

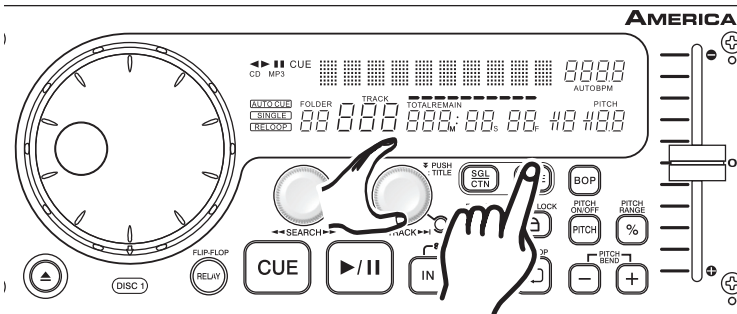

Figure 23

15. RESET MEMORY:

You may reset the system memory at any time. This will reset all your programmed menus and restore the unit to its default settings. Press the **TIME BUTTON** until "PRESET MODE" is displayed. Now turn the **TRACK KNOB** until "RESET ALL?" is displayed and then press the **TRACK KNOB** and "ERASING" should be displayed.

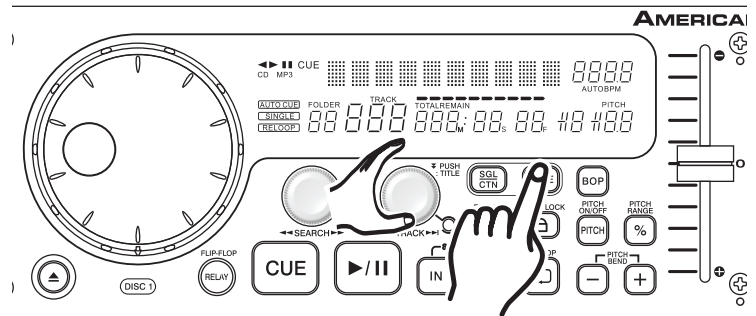

Figure 24

16. FIRMWARE VERSION DISPLAY:

You may display the units firmware version. Firmware is the units internal programming code. To view the firmware version; Press the **TIME BUTTON** for 2 sec. until "PRESET MODE" is displayed. Now turn the **TRACK KNOB** until "VER. XXXXXX" (X being the version number) is displayed in the VFD (2).

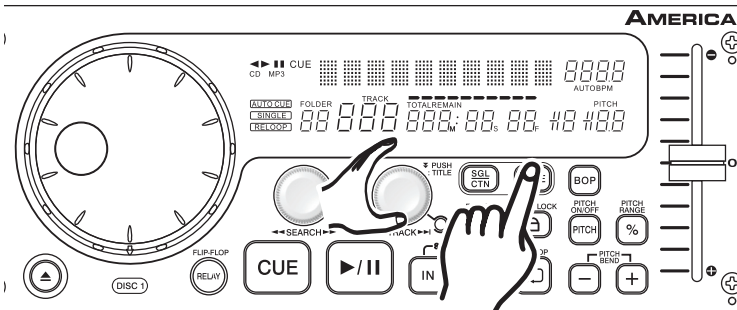

Figure 25

PITCH ADJUSTMENTS

PITCH ADJUSTMENTS:

The different pitch adjustments allow a track's or a loop's playback speed to be manipulated. This speed manipulations is commonly used to beat match between two or more music sources such as a turntable or another CD played. The playback speed may be increased or decreased by a factor of +/-100. The next section details the different pitch manipulation schemes. **NOTE: WHEN A MP3 DISC IS LOADED THE PITCH PERCENTAGE PLAYBACK SPEED MAY ONLY BE INCREASED OR DECREASED BY A FACTOR OF +/-16.**

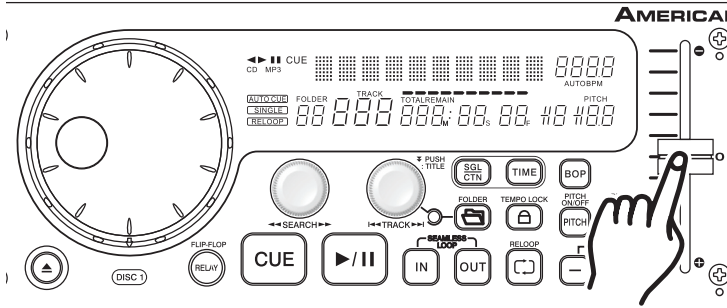

Figure 26

Activating the Pitch slider (3): To activate the *PITCH SLIDER* you must turn on the pitch adjustment function. Press the *PITCH ON/OFF BUTTON (10)*. The *PITCH ON/OFF BUTTON L.E.D.* will glow when the function is activated. If the pitch function is not activated the *PITCH SLIDER* will not function.

1. PITCH SLIDER (3):

This function will increase or decrease the tracks playback speed or "PITCH." The maximum pitch percentage manipulation in this function is +/-100%. The *PITCH SLIDER* is used to decrease or increase the playback pitch. If the slider is move up (towards the top of the unit) the pitch will decrease, if the slider is moved down (towards the bottom of the unit) the pitch will increase. The *PITCH SLIDER* adjustment can be changed to range from +/-4%, +/-8%, +/-16%, or +/-100% (See changing "PITCH SLIDER PERCENTAGE RANGE" on the next page). This pitch adjustments will effect normal playback and loops only when the *PITCH ON/OFF BUTTON (10)* is turned on. The pitch adjustments will not affect your loops.

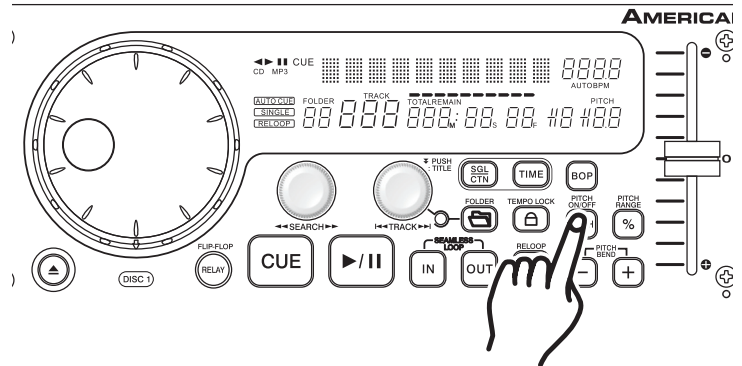

Figure 27

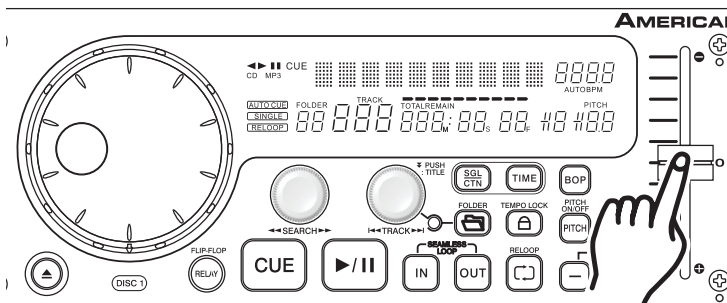

Figure 28

Using the Pitch slider (3): Be sure the pitch function has been engaged as described above. To use the *PITCH SLIDER* slide the slider up and down. Down will increase the pitch and up will decrease the pitch.

PITCH ADJUSTMENTS

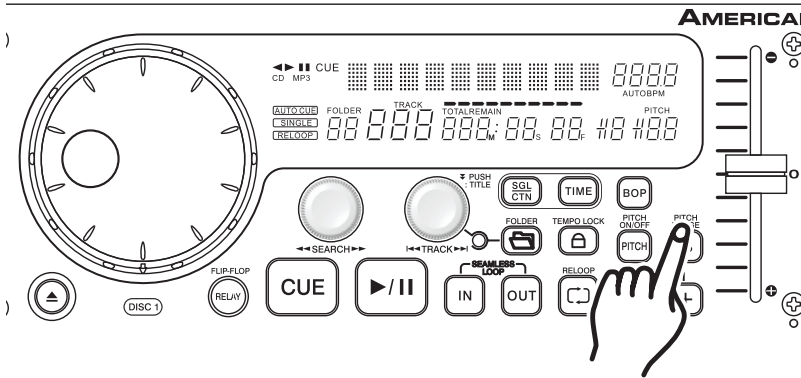

Figure 29

Using the Pitch Slider Percentage Selector (3): You may choose a pitch operating range at any time. To change the operating range be sure the pitch function is turned on, see figure 29. The pitch percentage can be changed between +/-4%, +/-8%, +/-16%, or (+/- 100% for CD). 4% will allow the least amount of pitch manipulation and 16% or (100% for CD) will allow the most amount of pitch manipulation. To adjust the different values, tap on the % **BUTTON (11)** until your desired value is reached.

2. PITCH BENDING:

Unlike the **PITCH SLIDER (3)** adjustment this function will momentarily increase or decrease a tracks speed during playback. There are two ways to operate this function with the (-) & (+) **PITCH BEND BUTTONS (14)** or with the **JOG WHEEL (1)**. The maximum pitch bend percentage allowed is +/- 16% or (+/- 100% for CD). The pitch bend function will work in conjunction with the **PITCH SLIDER (3)** pitch setting. For example, if the **PITCH SLIDER (3)** is set to a 2% pitch gain the pitch bending process will begin at 2% and will continue to the maximum of +/-16% or (+/- 100% for CD).

NOTE: A -100% pitch manipulation will stop playback entirely.

Holding down on the (-) **PITCH BEND BUTTON (14)** will provide a slow down in the playback pitch.

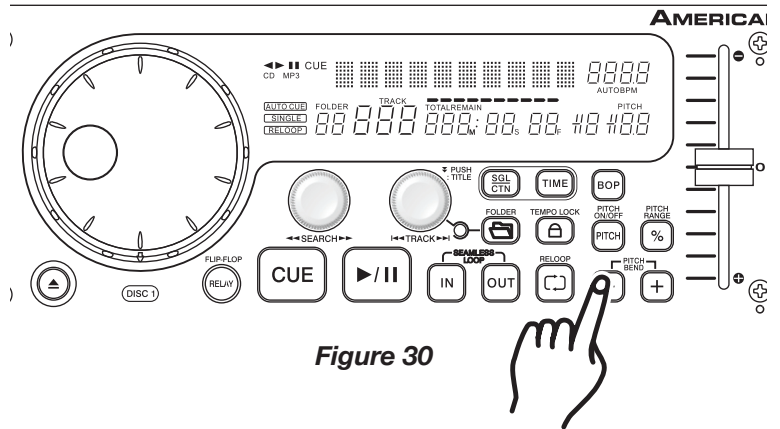

Figure 30

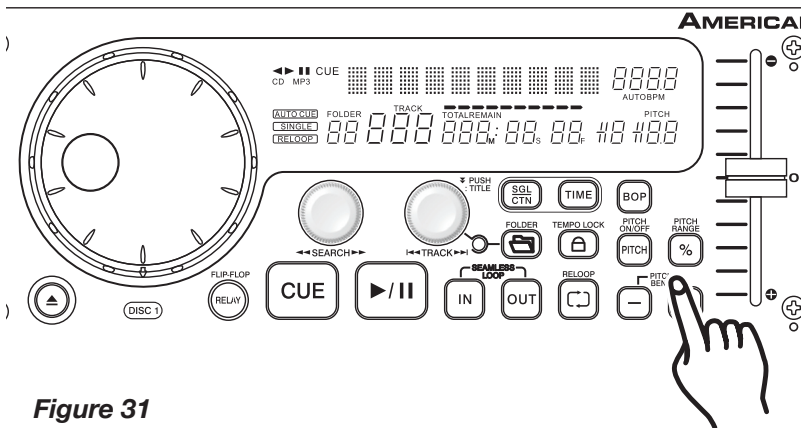

Figure 31

Holding down on the (+) **PITCH BEND BUTTON (14)** will provide a speed bump in the playback pitch.

PITCH ADJUSTMENTS

3. PITCH BEND BUTTONS (14):

The (+) *PITCH BEND BUTTON (14)* will increase track playback speed and the (-) *PITCH BEND BUTTON (14)* will decrease track playback speed. The extent to which the speed changes is proportionate to the amount of time the button is pressed. For example, if the (+) *PITCH BEND BUTTON (14)* is held down continuously as in figure 31, the disc speed will increase and will continue to increase until it reaches a maximum of 16% or (100% for CD) speed gain. When you release the (+) *PITCH BEND BUTTON (14)* the disc speed will automatically return to its previous set speed.

4. JOG WHEEL (1):

The *JOG WHEEL* will temporarily bend the pitch if a track is in playback mode. Rotating the wheel in a clockwise direction will increase your track pitch and rotating the wheel in a counter-clockwise direction will slow your track pitch. The speed you rotate the *JOG WHEEL* will determine pitch bend percentage (%). For example, if the *JOG WHEEL* is continuously turned in a counter-clockwise direction the playback speed will steadily decrease and will continue to decrease until playback reaches a maximum of -100% and playback stops entirely. When you stop turning the *JOG WHEEL* the disc speed will automatically return to its previous set speed.

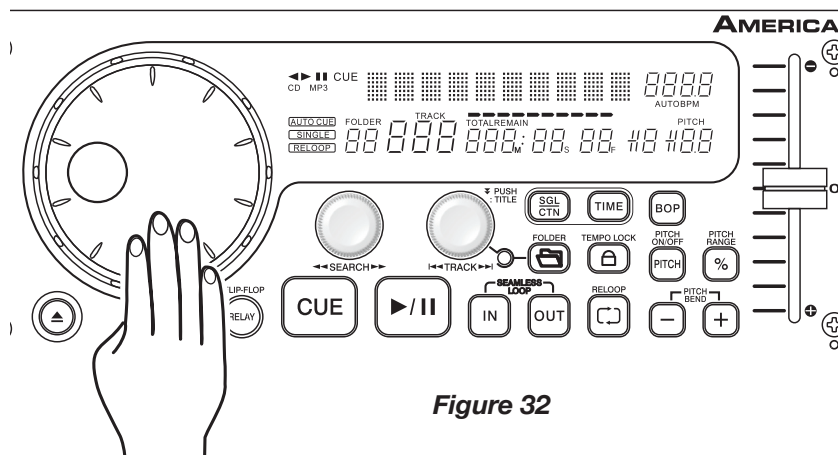

Figure 32

BOP EFFECT

CREATING A BOP EFFECT:

The Bop Effect is a stutter effect that is similar to turntable scratching. You can use this effect to create tricks in your mixing. Creating a BOP effect is a simple process:

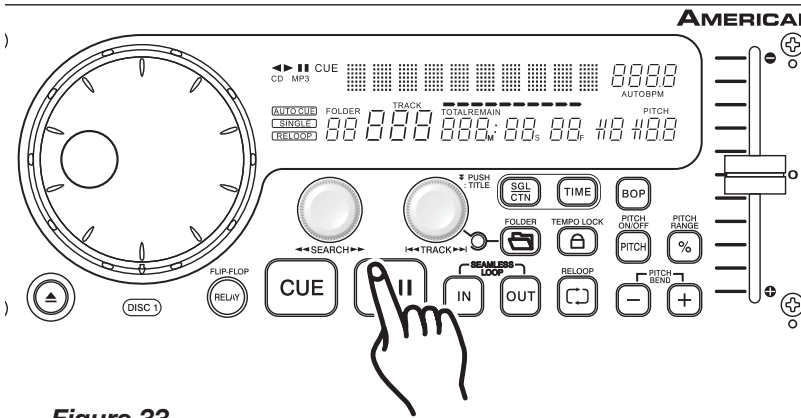

Figure 33

- 1) Press the *PLAY/PAUSE BUTTON* (18) so music is playing (Figure 33).

- 2) Press the *IN BUTTON* (17) (Figure 34) at the point you want your BOP to take place.

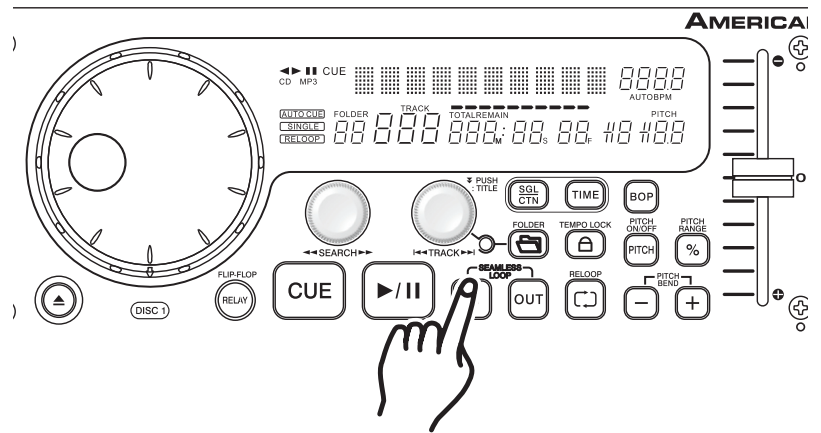

Figure 34

- 3) Now tap the *BOP BUTTON* (9) (Figure 35). It will produce a stutter effect as quickly as you tap on the *BOP BUTTON* (9).

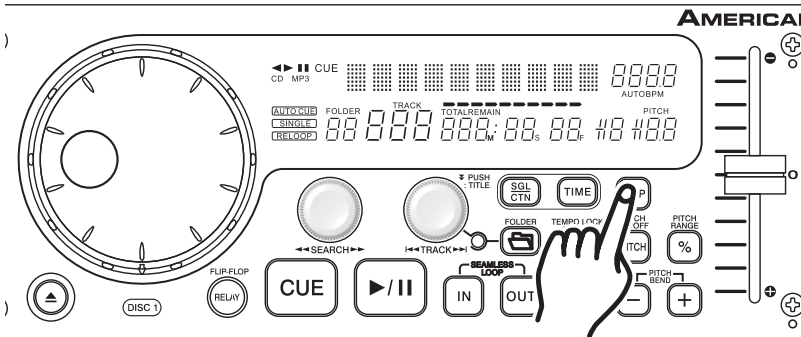

Figure 35

- 4) When you discontinue the BOP effect normal playback will resume from the point you initial started your BOP.

ACCESSING MP3 FOLDERS

ACCESS MP3 FOLDERS :

Use this function to access the different folders (files) located on your Mp3 disc.

1) Press the **FOLDER BUTTON (13)** to display the folder selection. See **FOLDER INDICATOR (54)** on page 14.

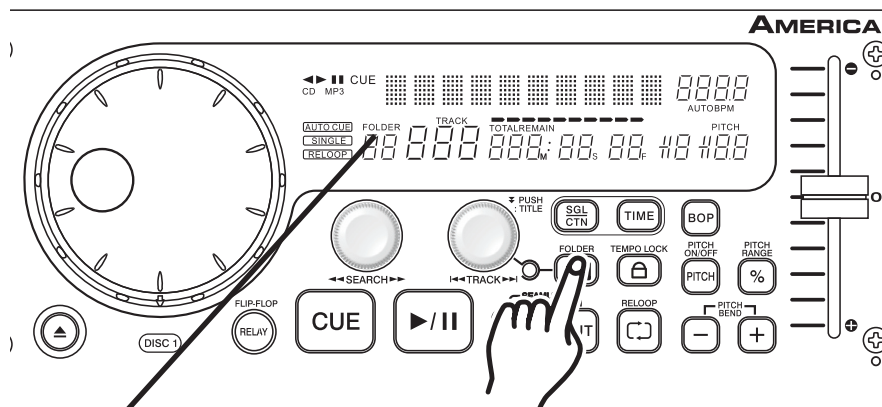
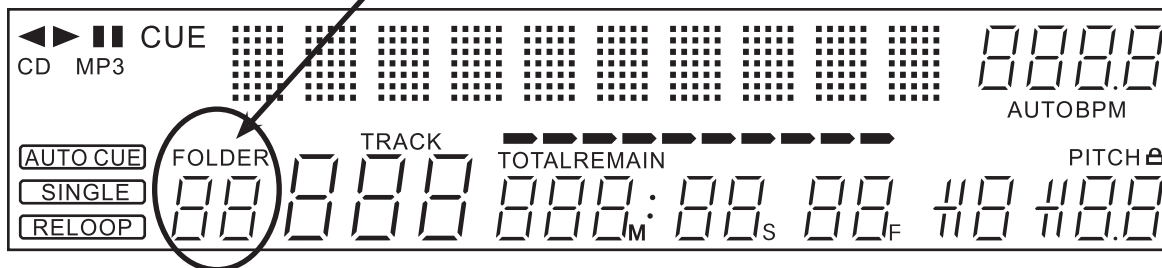

Figure 36



2) Now, press the **TRACK KNOB (5)** and turn it clockwise to scroll forward through the folders or turn it counter clockwise to scroll backwards through the folders.

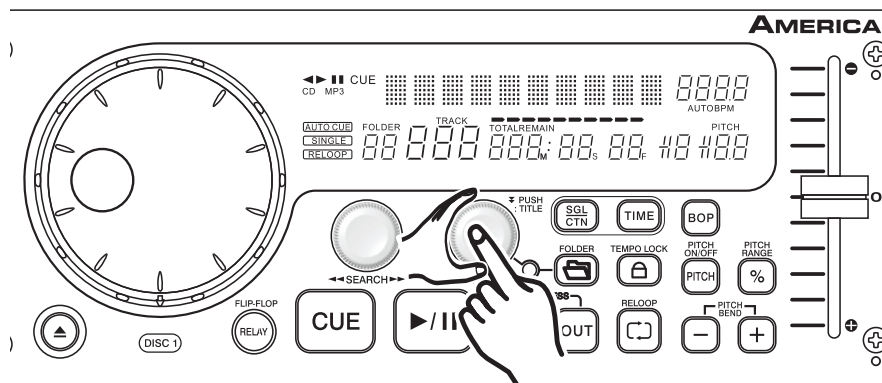

Figure 37

12. FLIP-FLOP™

This feature is a kind of "auto pilot." "Flip-Flop™" mode can only function with the both drives of the MCD-710. The "Flip-Flop" function can work with the player connected to a mixer, but it will only work with an American Audio® or American DJ® "Q" Start mixer. Also, the "Flip-Flop" function can work with the cd player connected directly to speakers, without the mixer. With "Flip-Flop™" you can have one disc drive begin playback when the other ends. You can "Flip Flop™" single tracks, or entire discs. **NOTE: When the cd player is connected directly to the speakers, without a mixer, the player can only "Flip-Flop" in single mode. It cannot "Flip-Flop" entire discs. To "Flip-Flop" entire discs, the player must be connected to a mixer.**

FLIP-FLOP™ connection and set-up using a mixer:

- 1) Connect your system as described under "'FLIP-FLOP" CONNECTED TO A "Q" START MIXER on the next page.
- 2) Turn the "Q" Start functions on your mixer to "on", and set your American Audio® "Q" Deck™ mixers' crossfader to the center position.
- 3) Load disc drives with audio discs.
- 4) Press the FLIP FLOP/RELAY BUTTON (20) to activate "Flip-Flop™" mode. Then press the SGL/CTN BUTTON (7) to choose between SINGLE mode or CONTINUOUS mode.
- 5) After they have both cued, press the PLAY/PAUSE BUTTON (18) on one of your drives to begin playback.
- 6) If you have the cd player set to SINGLE mode, the first cds' single track will play and after it has ended the second cds' track will immediately begin playback. If the player is set to CONTINUOUS mode, the first cd will play all the way through, and then after it has ended the second cd will start.
- 7) FLIP FLOP™ will continue until you stop it or power is interrupted.

FLIP-FLOP™ connection and set-up direct to speakers:

- 1) Connect your system as described under "'FLIP-FLOP" CONNECTED DIRECT TO SPEAKERS" on the next page.
- 2) Connect CONTROL START UNIT 1 to CONTROL START UNIT 2 on the back of the remote controller.
- 3) Load disc drives with audio discs.
- 4) Press the FLIP FLOP/RELAY BUTTON (20) to activate "Flip-Flop™" mode. Then press the SGL/CTN BUTTON (7) to choose SINGLE mode. **The "Flip-Flop" function, when connected in this way cannot "Flip-Flop" entire cds.**
- 5) After they have both cued, press the PLAY/PAUSE BUTTON (18) on one of your drives to begin playback.
- 6) Once the first cds' single track has ended the second cds' track will immediately begin playback.
- 7) FLIP FLOP™ will continue until you stop it or power is interrupted.

"FLIP-FLOP" SET UP INSTRUCTIONS

"FLIP-FLOP" (RELAY) CONNECTED TO A "Q" START MIXER

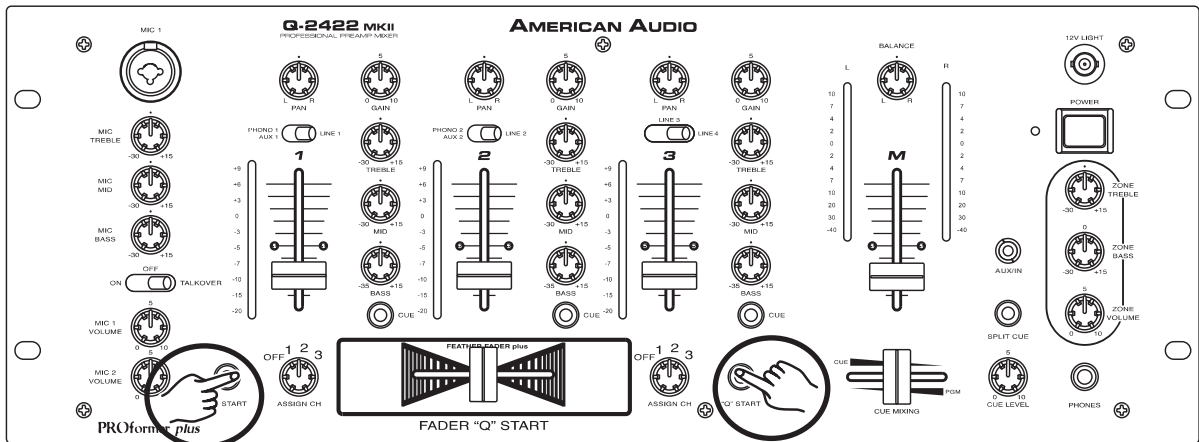
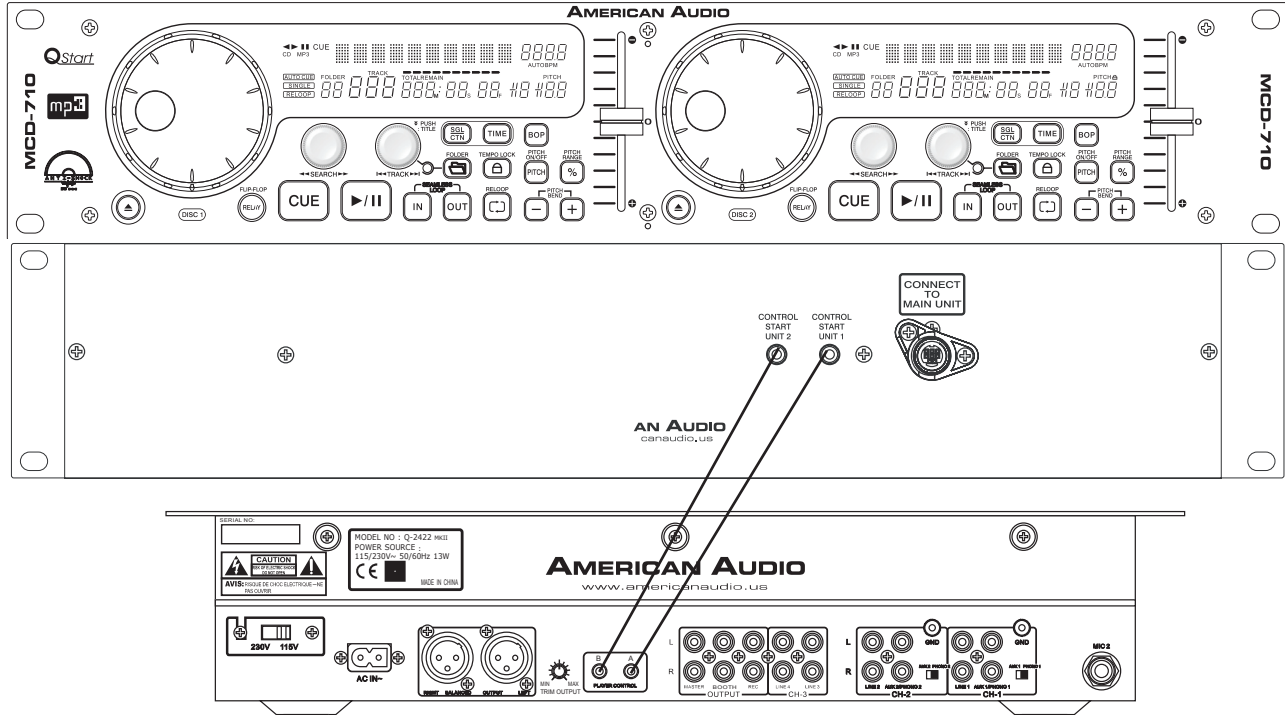

"FLIP-FLOP" (RELAY) CONNECTED DIRECT TO SPEAKERS

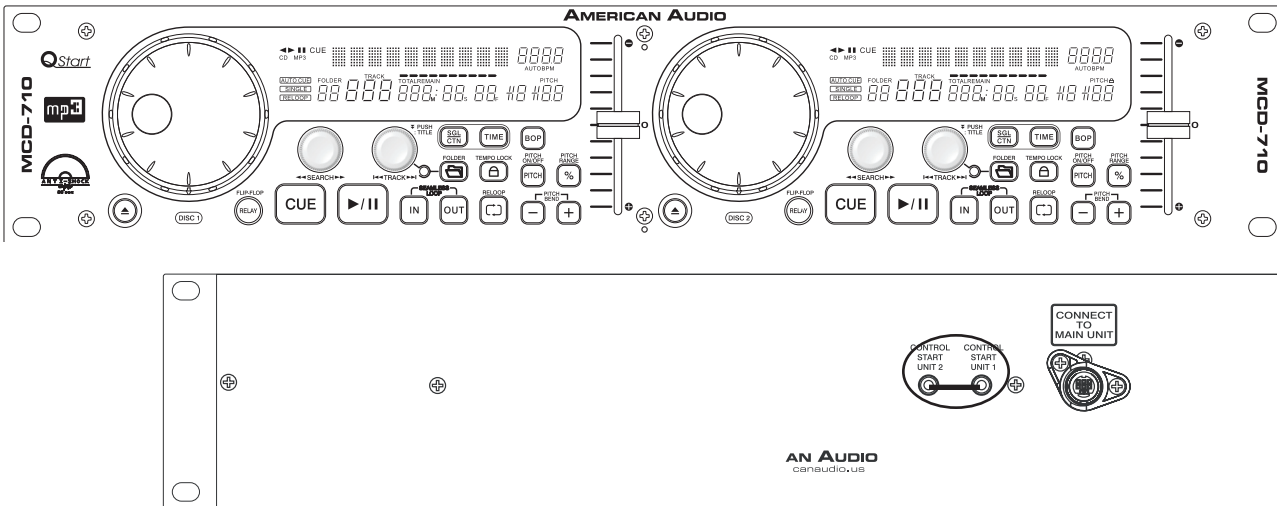

BEFORE SWITCHING OFF THE POWER

- When you have finished using the CD unit, and before switching off the power, be sure that the disc holder has been closed with the OPEN/CLOSE button.
- TRAY PROTECTION: If tray is not closed after 60 seconds, it will close automatically and pause.

CAUTION: DO NOT forcibly close the disc holder when the power is off.

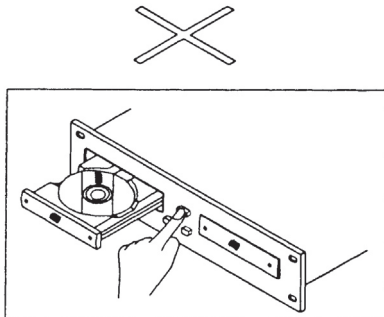

Do not switch off the power when the disc holder is open.

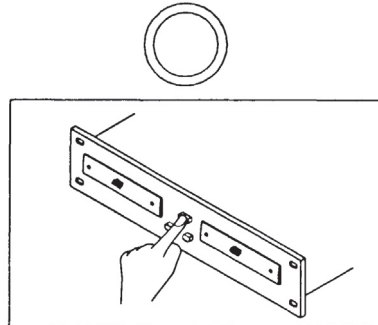

Switch off the power after the disc holder has been closed with the OPEN/CLOSE button.

DO NOT switch off the power when the disc holder is open. Switch off the power after the disc holder has been closed with the OPEN/CLOSE BUTTON (25 & 27).

COMPACT DISCS

1. PRECAUTIONS ON HANDLING COMPACT DISCS

Compact disc are constructed of the same types of plastic record are. To avoid severe damage to you valuable disc please observe the following guide lines. Following the these guide lines will ensure long disc life.

- Do not allow fingerprints, oil or dust to get on the surface of the disc. If the disc is dirty, wipe it off with a soft dry cloth.
- Do not use benzene, thinner, water, record spray, electrostatic-proof chemicals, or silicone-treated cloths to clean discs.
- Always handle discs carefully to prevent damaging the surface; in particular when removing a disc from the jewel case.
- Do not bend the disc.
- Do not apply heat.
- Do not enlarge the hole in the center of the disc.
- Do not write on the label (printed side) with a hard tipped implement such as a pencil or ball point pen.
- Condensation will form if a disc is brought into a warm area from a colder one, such as outdoors in winter. Do not attempt to dry the disc with a hair dryer, etc.

2. PRECAUTION ON STORAGE

- After playing a disc, always unload it from the unit.
- Always store the compact disc in the jewel case, protecting from dirt or damage.
- Do not place discs in the following areas:
 - a) Areas exposed to direct sunlight for a considerable time.
 - b) Areas subject to accumulation of dust or high humidity.
 - c) Areas affected by heat from indoor heaters, etc.

WARRANTY

WARRANTY INFORMATION: The MCD-710™ carries a ONE year (365 days) limited warranty. This warranty covers parts and labor. Please fill out the enclosed warranty card to validate your purchase and warranty. All returned service items whether under warranty or not, must be freight pre-paid and accompany a return authorization (R.A.) number. If the unit is under warranty, you must provide a copy of your proof of purchase invoice. Please contact American Audio® customer support at (800) 322-6337 for a R.A. number. All package not displaying a R.A. number on the outside of the package will be returned to the shipper.

1-YEAR LIMITED WARRANTY

A. American Audio® hereby warrants, to the original purchaser, American Audio® products to be free of manufacturing defects in material and workmanship for a period of 1 Year (365 days) from the date of purchase. This warranty shall be valid only if the product is purchased within the United States of America, including possessions and territories. It is the owner's responsibility to establish the date and place of purchase by acceptable evidence, at the time service is sought.

B. For warranty service, send the product only to the American Audio® factory. All shipping charges must be pre-paid. If the requested repairs or service (including parts replacement) are within the terms of this warranty, American Audio® will pay return shipping charges only to a designated point within the United States. If the entire instrument is sent, it must be shipped in its original package. No accessories should be shipped with the product. If any accessories are shipped with the product, American Audio® shall have no liability whatsoever for loss of or damage to any such accessories, nor for the safe return thereof.

C. This warranty is void if the serial number has been altered or removed; if the product is modified in any manner which American Audio® concludes, after inspection, affects the reliability of the product; if the product has been repaired or serviced by anyone other than the American Audio® factory unless prior written authorization was issued to purchaser by American Audio®; if the product is damaged because not properly maintained as set forth in the instruction manual.

D. This is not a service contract, and this warranty does not include maintenance, cleaning or periodic check-up. During the period specified above, American Audio® will replace defective parts at its expense, and will absorb all expenses for warranty service and repair labor by reason of defects in material or workmanship. The sole responsibility of American Audio® under this warranty shall be limited to the repair of the product, or replacement thereof, including parts, at the sole discretion of American Audio®. All products covered by this warranty were manufactured after January 1, 1990, and bear identifying marks to that effect.

E. American Audio® reserves the right to make changes in design and/or improvements upon its products without any obligation to include these changes in any products theretofore manufactured.

F. No warranty, whether expressed or implied, is given or made with respect to any accessory supplied with products described above. Except to the extent prohibited by applicable law, all implied warranties made by American Audio® in connection with this product, including warranties of merchantability or fitness, are limited in duration to the warranty period set forth above. And no warranties, whether expressed or implied, including warranties of merchantability or fitness, shall apply to this product after said period has expired. The consumer's and or Dealer's sole remedy shall be such repair or replacement as is expressly provided above; and under no circumstances shall American Audio® be liable for any loss or damage, direct or consequential, arising out of the use of, or inability to use, this product.

G. This warranty is the only written warranty applicable to American Audio® Products and supersedes all prior warranties and written descriptions of warranty terms and conditions heretofore published.

SPECIFICATIONS

GENERAL

Model: American Audio® MCD-710™ - Professional CD Player

Type:	Tray loading, digital compact disc audio player.
Disc type:	Standard size compact discs (5 in/12cm and 3in/8cm) CD-R, and CD-RW
Pitch Range:	Within +/- 4%, +/- 8%, +/- 16%, (+/- 100% for CD)
Pitch Bend:	+/- 4%, +/- 8%, +/- 16%, (+/- 100% for CD)
Pitch Accuracy:	+/- 0.15%
Dimensions:	Main Unit: 482(W) x 88.8(H) x 310(D) mm 19"(W) x 3.49"(H) x 12.18"(D) Control Unit: 482(W) x 88.8(H) x 96(D) mm 19"(W) x 3.49"(H) x 3.80"(D)
Installation:	Place on flat surface or mount in flat case
Weight:	Main Unit: 12.5 Lbs. / 5.7 Kgs Control Unit: 3.7 Lbs. / 1.7 Kgs
Power supply:	AC 115/230V, 50/60Hz User Selectable Single Voltage: AC 100V, 50/60Hz (Japan) AC 110V, 60Hz (Colombia) AC 120V, 60Hz (U.S.A. and Canada) AC 127V, 60Hz (Mexico) AC 220V, 50Hz (Chile and Argentina) AC 220V, 60Hz (Philippines and Korea) AC 230V, 50Hz (Europe, New Zealand, South Africa, and Singapore) AC 240V, 50Hz (Australia and U.K.)
Power consumption:	24W
Environmental conditions:	Operational temperature: 5 to 35°C (41 to 95°F) Operational humidity: 25 to 85% RH (no condensation) Storage temperature: -20 to 60°C (4 to 140°F)
Accessories:	Connecting RCA Cable (2 sets for left and right channels) Control 1/8" miniplug type (3 feet)

AUDIO SECTION

Quantization:	16 bit linear per channel
Sampling rate:	44.1 kHz at normal pitch
Over sampling rate:	8 times
D/A conversion	16 bit

AUDIO CHARACTERISTICS (TEST DISC: TCD-782, LOAD=47Kohm)

ITEM	NORMAL	LIMIT	CONDITION
Output level	2Vrms+/-0.5dB	2V+/-1dB	1KHz,0dB
Channel balance	Within 0.1dB	Within 1dB	1KHz,0dB
Frequency response	20Hz-20KHz +/-0.4dB	20Hz-20KHz+/-1dB	0dB Output
De-emphasis response	-17.6 ~ -20dB	-17 ~ -20dB	16KHz,-20dB
Channel separation*	100dB	90dB	1KHz,0dB
T.H.D. + NOISE*	0.006%	0.01%	1KHz,0dB
S/N ratio (IHF-A)*	102dB	90dB	1KHz,0dB

NOTE: * With 20KHz low pass filter.

SEARCHING TIME (TEST DISC: TCD-792)

ITEM	NORMAL	LIMITS	CONDITION
Short access time	2sec	4sec	Play next track
Long access time	4sec	6sec	Track 1 ->Track 20 Track 20 ->Track 1

PLAYABILITY

ITEM	NORMAL	LIMIT	CONDITION
Interruption	1mm	0.7mm	TCD-725
Black dot	1mm	0.6mm	TCD-725
Finger prints	75um	65um	TCD-725
Eccentricity	140um	140um	TCD-712 W/O TRACK JUMP
Vertical deviation	1mm	0.5mm	TCD-731R

PICK-UP

System	Object lens drive system optical pick-up
Object lens drive system	2 dimensional parallel drive

SPECIFICATIONS

Tracking detection	3 spot beam detection
Optical source	Semiconductor laser
Wave length	780nm

NOTES: *Specifications and improvements in the design of this unit and this manual are subject to change without any prior written notice.*

CHECK THE AMERICAN AUDIO WEBSITE FOR DOWNLOADABLE USER SOFTWARE UPDATES.



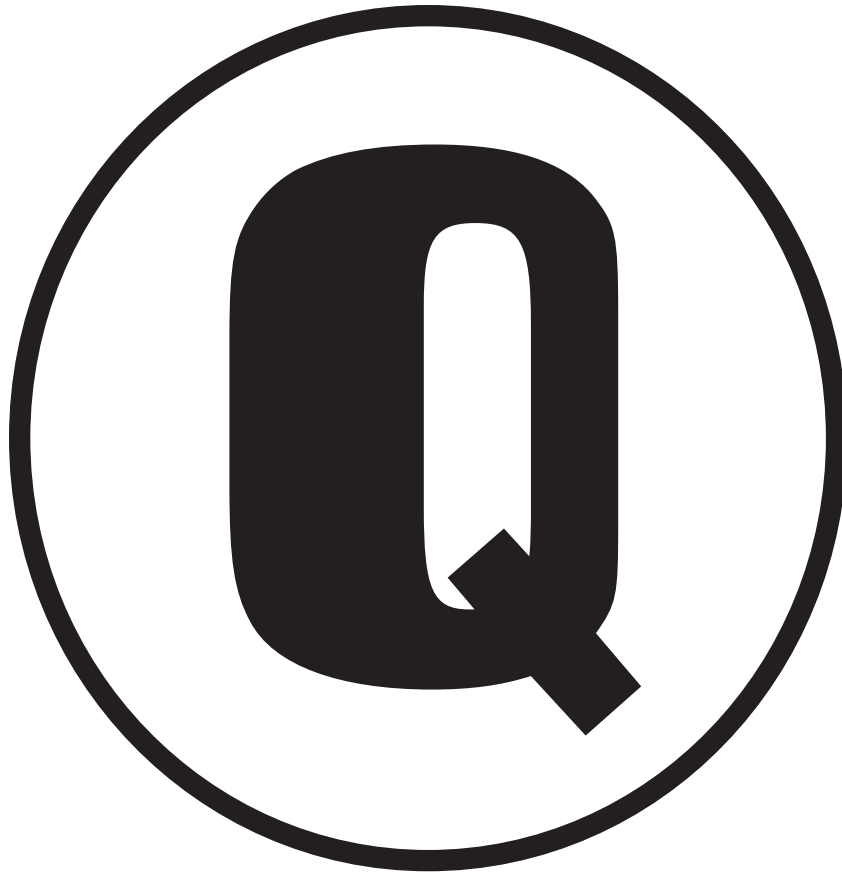

©American Audio® World Headquarters:
4295 Charter Street Los Angeles, CA 90058 USA
Tel: 323-582-3322 Fax: 323-582-3311
Web: www.americanaudio.us E-mail: info@americanaudio.us