

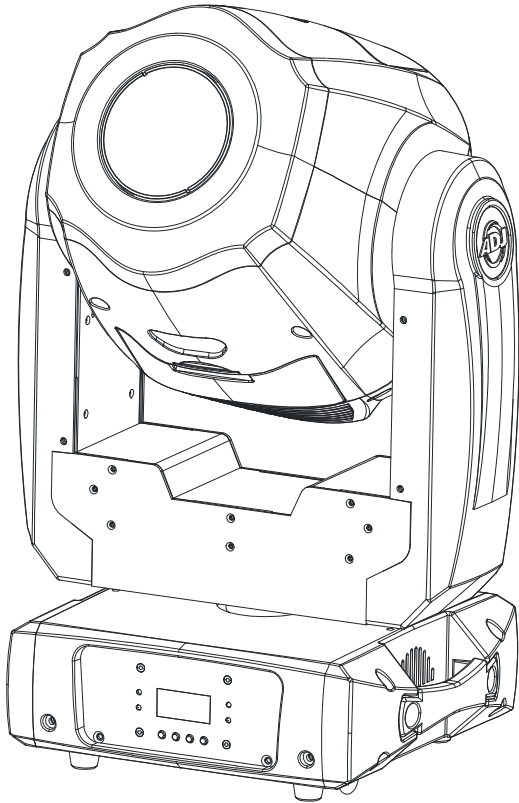

Inno Spot Elite



User Instructions

©2013 ADJ Products, LLC all rights reserved. Information, specifications, diagrams, images, and instructions herein are subject to change without notice. ADJ Products, LLC logo and identifying product names and numbers herein are trademarks of ADJ Products, LLC. Copyright protection claimed includes all forms and matters of copyrightable materials and information now allowed by statutory or judicial law or hereinafter granted. Product names used in this document may be trademarks or registered trademarks of their respective companies and are hereby acknowledged. All non-ADJ Products, LLC brands and product names are trademarks or registered trademarks of their respective companies.

ADJ Products, LLC and all affiliated companies hereby disclaim any and all liabilities for property, equipment, building, and electrical damages, injuries to any persons, and direct or indirect economic loss associated with the use or reliance of any information contained within this document, and/or as a result of the improper, unsafe, insufficient and negligent assembly, installation, rigging, and operation of this product.

Europe Energy Saving Notice
Energy Saving Matters (EuP 2009/125/EC)
Saving electric energy is a key to help protecting the environment. Please turn off all electrical products when they are not in use. To avoid power consumption in idle mode, disconnect all electrical equipment from power when not in use. Thank you!

Inno Spot Elite

General Information

Unpacking: Thank you for purchasing the Inno Spot Elite by ADJ Products, LLC. Every Inno Spot Elite has been thoroughly tested and has been shipped in perfect operating condition. Carefully check the shipping carton for damage that may have occurred during shipping. If the carton appears to be damaged, carefully inspect your fixture for any damage and be sure all equipment necessary to operate the unit has arrived intact. In the event damage has been found or parts are missing, please contact our toll free customer support number for further instructions. Please do not return this unit to your dealer without contacting customer support first.

Introduction: The Inno Spot Elite is a 15 channel, DMX intelligent, moving head, LED fixture. The Inno Spot Elite can operate as a stand alone fixture or in a Master/Slave configuration. The Inno Spot Elite has three operating modes; a sound active, show mode, DMX controlled. This fixture is suitable for theaters, studios, retail stores, and other similar locations. *For best results use fog or special effects smoke to enhance the beams projections.*

Customer Support: ADJ Products, LLC provides a toll free customer support line, to provide help and to answer any question should you encounter problems during your set up or initial operation. You may also visit us on the web at www.adj.com for any comments or suggestions. Service Hours are Monday through Friday 8:00 a.m. to 4:30 p.m. Pacific Standard Time.

Voice: (800) 322-6337
Fax: (323) 582-2941
E-mail: support@adj.com

Warning! To prevent or reduce the risk of electrical shock or fire, do not expose this unit to rain or moisture.

Warning! *This may cause severe eye damage. Avoid looking directly into the light source at all times!*

Inno Spot Elite

General Instructions

To optimize the performance of this product, please read these operating instructions carefully to familiarize yourself with the basic operations of this unit. These instructions contain important safety information regarding the use and maintenance of this unit. Please keep this manual with the unit, for future reference.

Inno Spot Elite

Features

- 15 DMX Channels
- 7 Colors + White
- 7 Rotating, Replaceable Gobos + Spot (6 Glass & 1 Metal Gobo)
- 3 Operating Modes - Sound Active, Show Mode, & DMX Control
- Internal Microphone
- Digital Display for Address and Function Setting
- UC3 Controller (Not Included)
- 4 Preprogrammed Shows
- Power Cord Daisy Chain (See page 9)

Inno Spot Elite

Warranty Registration

The Inno Spot Elite carries a 3 year (1095 days) limited warranty. Please fill out the enclosed warranty card to validate your purchase and warranty. You may also register your product online at www.adj-products.com. All returned service items whether under warranty or not, must be freight pre-paid and accompany a return authorization (R.A.) number. If the unit is under warranty you must provide a copy of your proof of purchase invoice. Please contact ADJ Products, LLC customer support for a R.A. number.

Inno Spot Elite

Handling Precautions

Caution! There are no user serviceable parts inside this unit. Do not attempt any repairs yourself, doing so will void your manufactures warranty. In the unlikely event your unit may require service please contact ADJ Products, LLC.

During operation the housing may become extremely hot. Avoid touching the unit with bare hands while in use.

ADJ Products, LLC will not accept any liability for any resulting damages caused by the non-observance of this manual or any unauthorized modification to this unit.

For Your Own Personal Safety, Please Read and Understand This Manual Completely Before You Attempt To Install Or Operate This Unit!

- To reduce the risk of electrical shock or fire, do not expose this unit rain or moisture
- Do not spill water or other liquids into or on to your unit.
- Be sure that the local power outlet match that of the required voltage for your unit.
- Do not attempt to operate this unit if the power cord has been frayed or broken.
- Do not attempt to remove or break off the ground prong from the electrical cord. This prong is used to reduce the risk of electrical shock and fire in case of an internal short.
- Disconnect from main power before making any type of connection.
- Do not remove the cover under any conditions. There are no user serviceable parts inside.
- Never operate this unit when it's cover is removed.
- Always be sure to mount this unit in an area that will allow proper ventilation. Allow about 6" (15cm) between this device and a wall.
- Do not attempt to operate this unit, if it becomes damaged.
- This unit is intended for indoor use only, use of this product outdoors voids all warranties.
- Always mount this unit in safe and stable matter.
- Power-supply cords should be routed so that they are not likely to be walked on or pinched by items placed upon or against them, paying particular attention to cords at plugs, convenience receptacles, and the point where they exit from the appliance.
- Cleaning -The fixture should be cleaned only as recommended by the manufacturer. See page 25 for cleaning details.
- Heat -This fixture should be situated away from heat sources such as radiators, heat registers, stoves, or other appliances (including amplifiers) that produce heat.
- The fixture should be serviced by qualified service personnel when:
 - A. Objects have fallen, or liquid has been spilled into the appliance.
 - B. The appliance has been exposed to rain or water.
 - C. The appliance does not appear to operate normally or exhibits a marked change in performance.

When installing the unit, the trussing or area of installation must be able to hold 10 times the weight without any deformation. When installing the unit must be secured with a secondary safety attachment, e.g. and appropriate safety cable. Never stand directly below the unit when mounting, removing, or servicing the unit.

Overhead mounting requires extensive experience, including calculating working load limits, installation material being used, and periodic safety inspection of all installation material and unit. If you lack these qualifications, do not attempt the installation yourself.

These installaiton should be checked by a skilled person once a year.

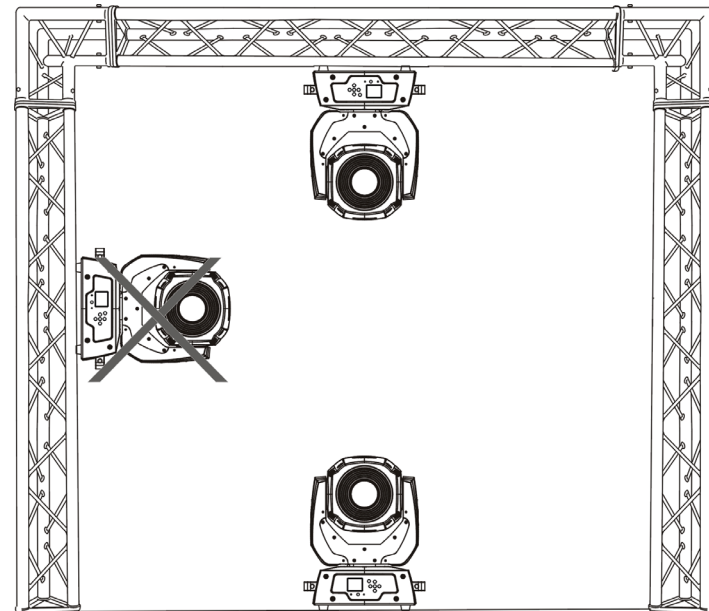

The Inno Spot Elite is fully operational in two different mounting positions, hanging upside-down from a ceiling or set on a flat level surface. To avoid internal damage to the unit, never mount the unit on its side as illustrated above. Be sure this fixture is kept at least 0.5m away from any flammable materials (decoration etc.). Always use and install the supplied safety cable as a safety measure to prevent accidental damage and/or injury in the event the clamp fails (see next page). Never use the carrying handles for secondary attachment.

NOTICE: The suitable environmental temperature for this lighting fixture is between -25° C to 45° C. Do not place this lighting fixture in an environment where the temperatures are under or above the temperatures stated above. This will allow the fixture to run at its best and help prolong the fixture life.

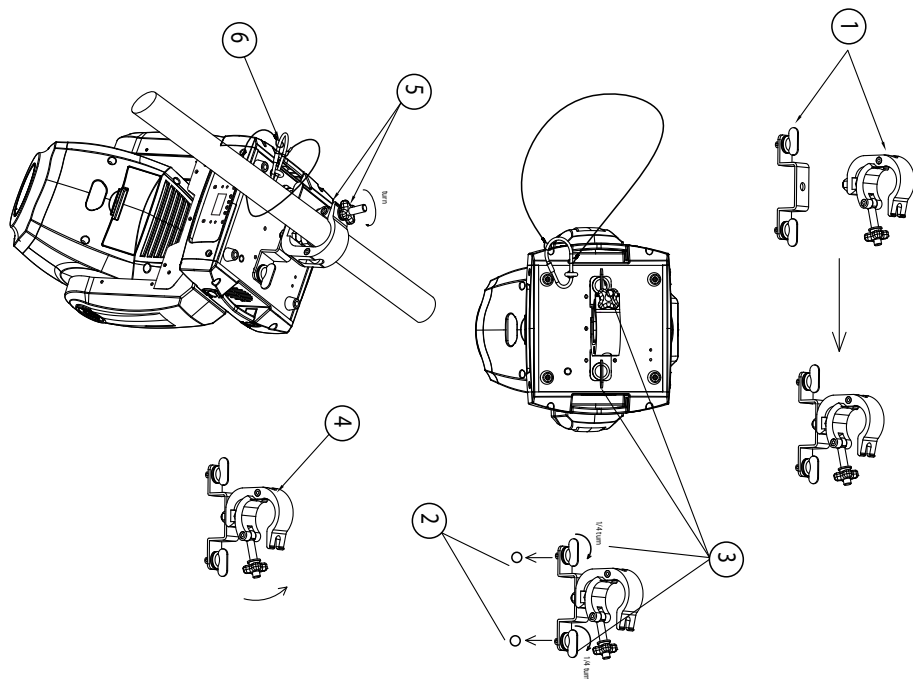

Screw one clamp via a M12 screw and nut onto the Omega holder. Insert the quick-lock fasteners of the Omega holder into the respective holes on the bottom of the Inno Spot Elite. Tighten the quick-lock fasteners fully clockwise. Pull the safety-cable through the safety-cable slot on the bottom of the base and over the trussing system or a safe fixation spot. Insert the end in the carabine and tighten the safety screw.

Power Supply: The ADJ Inno Spot Elite contains a automatic voltage switch, which will auto sense the voltage when it is plugged into a power source. With this switch there is no need to worry about the correct power voltage, this unit can be plugged in anywhere.

DMX-512: DMX is short for Digital Multiplex. This is a universal protocol used by most lighting and controller manufactures as a form of communication between intelligent fixtures and controllers. A DMX controller sends DMX data instructions from the controller to the fixture. DMX data is sent as serial data that travels from fixture to fixture via the DATA “IN” and DATA “OUT” XLR terminals located on all DMX fixtures (most controllers only have a DATA “OUT” terminal).

DMX Linking: DMX is a language allowing all makes and models of different manufactures to be linked together and operate from a single controller, as long as all fixtures and the controller are DMX compliant. To ensure proper DMX data transmission, when using several DMX fixtures try to use the shortest cable path possible. The order in which fixtures are connected in a DMX line does not influence the DMX addressing. For example; a fixture assigned a DMX address of 1 may be placed anywhere in a DMX line, at the beginning, at the end, or anywhere in the middle. Therefore, the first fixture controlled by the controller could be the last fixture in the chain. When a fixture is assigned a DMX address of 1, the DMX controller knows to send DATA assigned to address 1 to that unit, no matter where it is located in the DMX chain.

Data Cable (DMX Cable) Requirements (For DMX and Master/Slave Operation): The Inno Spot Elite can be controlled via DMX-512 protocol. The Inno Spot Elite is a 15 channel DMX unit. The DMX address is set electronically using the controls on the front panel of the unit. Your unit and your DMX controller require a approved DMX-512 110 Ohm Data cable for data input and data output (Figure 1). We recommend Accu-Cable DMX cables. If you are making your own cables, be sure to use standard 110-120 Ohm shielded cable (This cable may be purchased at almost all professional sound and lighting stores). Your cables should be made with



Figure 1

Inno Spot Elite

Set Up

a male and female XLR connector on either end of the cable. Also remember that DMX cable must be daisy chained and cannot be split.

Notice: Be sure to follow figures two and three when making your own cables. Do not use the ground lug on the XLR connector. Do not connect the cable's shield conductor to the ground lug or allow the shield conductor to come in contact with the XLR's outer casing. Grounding the shield could cause a short circuit and erratic behavior.

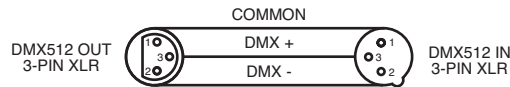

Figure 2

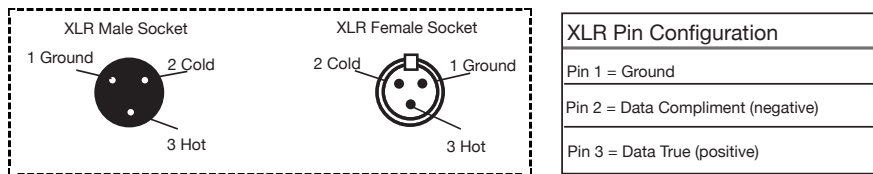

Figure 3

Special Note: Line Termination. When longer runs of cable are used, you may need to use a terminator on the last unit to avoid erratic behavior. A terminator is a 110-120 ohm 1/4 watt resistor which is connected between pins 2 and 3 of a male XLR connector (DATA + and DATA -). This unit is inserted in the female XLR connector of the last unit in your daisy chain to terminate the line. Using a cable terminator (ADJ part number Z-DMX/T) will decrease the possibilities of erratic behavior.



Termination reduces signal errors and avoids signal transmission problems and interference. It is always advisable to connect a DMX terminal, (Resistance 120 Ohm 1/4 W) between PIN 2 (DMX-) and PIN 3 (DMX +) of the last fixture.

Figure 4

Inno Spot Elite

Set Up

5-Pin XLR DMX Connectors. Some manufactures use 5-pin DMX-512 data cables for DATA transmission in place of 3-pin. 5-pin DMX fixtures may be implemented in a 3-pin DMX line. When inserting standard 5-pin data cables in to a 3-pin line a cable adaptor must be used, these adaptors are readily available at most electric stores. The chart below details a proper cable conversion.

3-Pin XLR to 5-Pin XLR Conversion		
Conductor	3-Pin XLR Female (Out)	5-Pin XLR Male (In)
Ground/Shield	Pin 1	Pin 1
Data Compliment (- signal)	Pin 2	Pin 2
Data True (+ signal)	Pin 3	Pin 3
Not Used		Pin 4 - Do Not Use
Not Used		Pin 5 - Do Not Use

Inno Spot Elite

Power Cord Daisy Chain

With this feature you can connect the fixtures to one another using the IEC input and output sockets. The quantity that can be connected is 4 fixtures maximum for 120V and 8 fixtures maximum for 240V. After the maximum fixtures has been reached you will need to use a new power outlet. They must be the same fixtures. DO NOT mix fixtures.

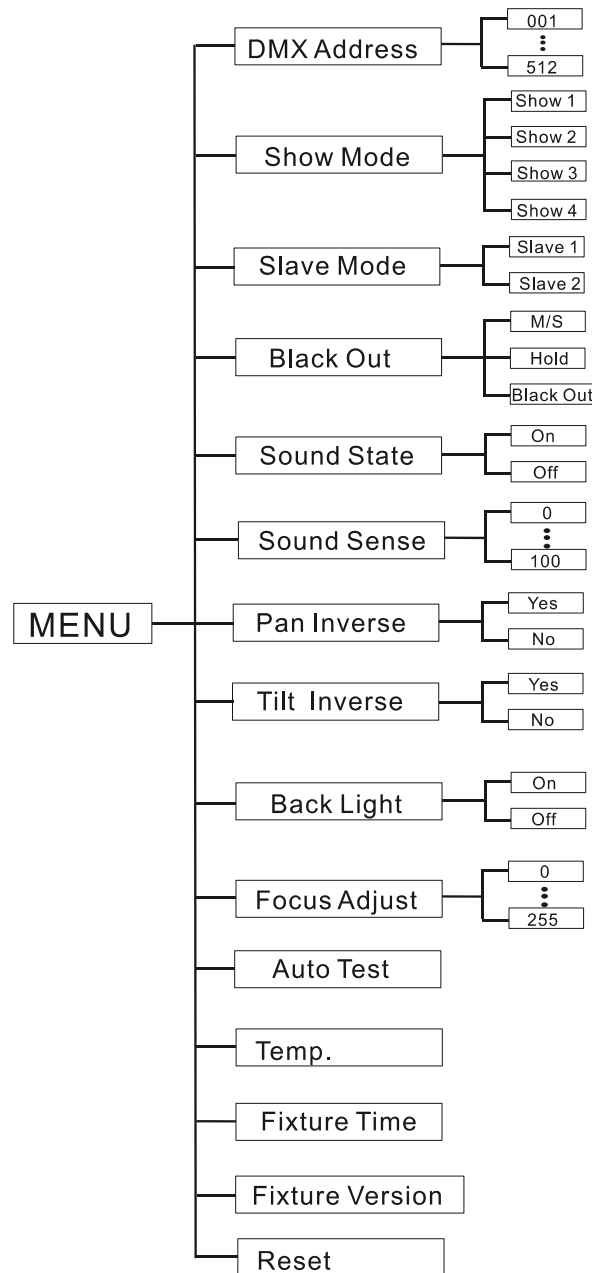

DMX Address - Set the DMX Address -

1. Press the MENU button until “DMX Address” is displayed, press ENTER.
2. “X” will now be displayed, “X” represents the displayed address. Press the UP or DOWN buttons to find your desired address.
3. Press ENTER to confirm, and then press and hold the MENU button for at least three seconds to assign.

Show Mode - Show modes 1 - 4 (Factory Shows).

1. Press the MENU button until “Show Mode” is displayed, press ENTER.
2. “Show X” will now be displayed, “X” representing a number between 1-4. Press the UP or DOWN buttons to find your desired show and press ENTER to confirm. After pressing ENTER, press and hold the MENU button for at least 3 seconds to activate.

SHOWS:

Show 1 - For fixtures placed on the floor, the tilt movement angle is 210°

Show 2 - For fixtures fixed to the ceiling or truss, the tilt movement angle is 90°.

Show 3 - For fixtures placed on a table or stage. The beam is projected at the audience’s direction; i.e. in front of the stage. Pan movement angle (left to right to left) is 160°. Tilt movement angle is 90°.

Show 4 - For fixtures fixed to the ceiling or truss. The beam is projected at the audience’s direction; i.e. in front of the stage. Pan movement angle (left to right to left) is 160°. Tilt movement angle is 90°.

Slave Mode - This will let you set unit as a slave in a master/slave configuration.

1. Press the MENU button until “Slave Mode” is displayed,
ADJ Products, LLC - www.adj.com - Inno Spot Elite Instruction Manual Page 11

press ENTER. Either “Slave 1” or “Slave 2” will be displayed.

2. Press the UP or DOWN buttons until your desired slave mode is displayed, press ENTER to confirm.

NOTE: In a Master/Slave configuration you can make one fixture the Master and then set the next fixture to “Slave 2”, the fixtures will now have contrast movement to each other.

Black Out - This mode can be used as a precaution mode, that in case the DMX signal is lost, the operating mode chosen in the setup is the running mode the fixture will go into when the DMX signal is lost. You can also set this as the operating mode you would like the unit to return to when power is applied.

1. Press the MENU button until “Black Out” is displayed, press ENTER.

2. Either “M/S” (Master/Slave), “Hold”, or “Black Out” will be displayed. Choose an operating mode you would like the unit to start up in when power is applied or the DMX signal is lost.

- M/S - If the DMX signal is lost or power is applied, the unit will automatically go into Master Slave mode.

- Hold - If the DMX signal is lost the fixture will stay in the last DMX set up. If power is applied and this mode is set, the unit will automatically go into the last DMX set up.

- Black Out - If the DMX signal is lost or power is applied, the unit will automatically go into stand by mode.

3. Press ENTER to confirm your desired set up.

Sound State - In this mode the unit will run in sound active mode.

1. Press the MENU button until “Sound State” is displayed, press

ENTER.

2. Either “On” or “Off” will now be displayed. Use the UP or DOWN buttons to toggle between “On” and “Off”.

3. Press ENTER to confirm your selection, the press and hold the MENU button to activate.

Sound Sense - In this mode you can adjust the sound sensitivity of the sound active mode.

1. Press the MENU button until “Sound Sense” is displayed, press ENTER.

2. Press the UP or DOWN buttons to adjust the sensitivity level. The sensitivity level can be adjusted between 0 (the lowest) and 100 (most sensitive).

3. Press ENTER to set you desired level.

Pan Inverse - Pan Inversion

1. Press the MENU button until “Pan Inverse” is displayed, press ENTER. Either “Yes” or “No” will be displayed.

2. To activate the Pan inversion press the UP or DOWN buttons until “Yes” is displayed, press ENTER to confirm. To deactivate Pan inversion, select “No” and press Enter.

Tilt Inverse - Tilt Inversion

1. Press the MENU button until “Tilt Inverse” is displayed, press ENTER. Either “Yes” or “No” will be displayed.

2. To activate the Tilt inversion press the UP or DOWN buttons until “Yes” is displayed, press ENTER to confirm. To deactivate Tilt inversion, select “No” and press Enter.

Back Light - With this function you can make the backlight automatically turn off after one minute.

1. Press the MENU button until “Back Light” is displayed, press ENTER.
2. Either “ON” or “OFF” will now be displayed. Press the UP or DOWN buttons to select “ON” to keep the backlight on at all times, or “OFF” to allow the backlight to turn off after 2 minutes. Press any button to turn the backlight on again.
3. Press ENTER to confirm.

Focus Adjust - With this function you can adjust the focus.

1. Press the MENU button until “Focus Adjust” is displayed, press ENTER.
2. A number between 0-255 will be displayed. This number represents the focus setting. Use the UP or DOWN buttons to adjust the focus to your desire.
3. When you have found your desired setting press ENTER to confirm.

Auto Test - This function will run a self test program.

1. Press the MENU button until “Auto Test” is displayed, press ENTER.
2. The fixture will now run a self test. Press the MENU button to exit.

Temp. - With this function you can display the running temperature of the unit.

1. Tap the MENU button until “Temp.” is displayed, press

ENTER.

2. The current running temperature of the fixture will now be displayed. Press MENU to exit.

Fixture Time - With this function you can display the running time of the unit.

1. Tap the MENU button until “Fixture Time” is displayed, press ENTER.
2. The running time of the fixture will now be displayed. Press MENU to exit.

Fixture Version - This will display the software version

1. Tap the MENU button until “Fixture Version” is displayed. Press the ENTER button and the software version will be displayed.
2. Press the MENU button to leave this function.

Reset - Use this function to reset the unit.

1. Tap the MENU button until “Reset” is displayed, press ENTER.
2. The fixture will now reset.

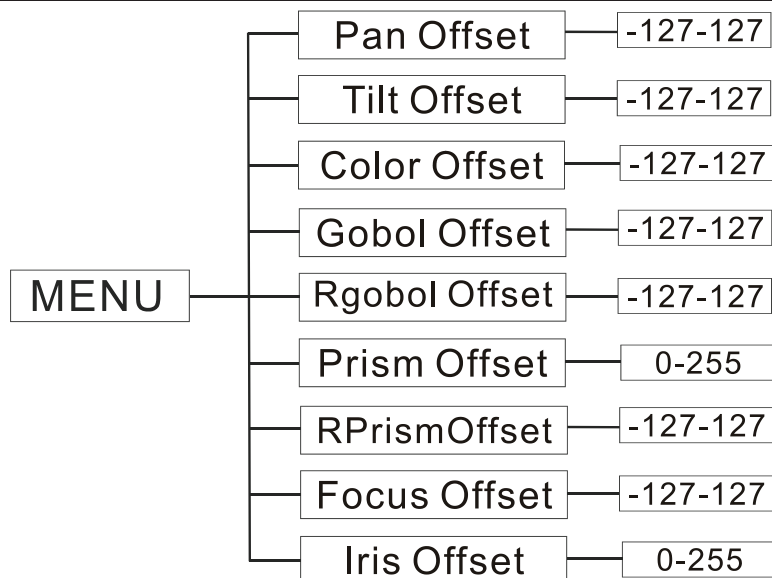

To enter the OTIL (Home position adjustment) & Gobo wheel adjustment submenu, press the ENTER button for at least 3 seconds. In this submenu you are able to adjust the home position of the pan, tilt, color wheel, gobo wheel, RGobo (Rotating) wheel, prism, R (Rotating) Prism, and focus position.

Pan Offset - Adjustment of the pan home position.

1. Press the ENTER button for at least 3 seconds, then press the UP or DOWN buttons so that “**Pan Offset**” is displayed, press ENTER.
2. Use the UP and DOWN buttons to make your adjustments, and then press ENTER to confirm. Press the MENU button for one second to exit.

Tilt Offset - Adjustment of the tilt home position.

1. Press the ENTER button for at least 3 seconds, then press the UP or DOWN buttons so that “**Tilt Offset**” is displayed, press ENTER.
2. Use the UP and DOWN buttons to make your adjustments, and then press ENTER to confirm. Press the MENU button for one second to exit.

Color Offset - Home setting adjustment for the color wheel.

1. Press the ENTER button for at least 3 seconds, then press the UP or DOWN buttons so that “**Color Offset**” is displayed, press ENTER.
2. Use the UP and DOWN buttons to make your adjustments, and then press ENTER to confirm. Press the MENU button for one second to exit.

Gobo Offset - Home setting adjustment for the gobo wheel.

1. Press the ENTER button for at least 3 seconds, then press the UP or DOWN buttons so that “**Gobo Offset**” is displayed, press ENTER.
2. Use the UP and DOWN buttons to make your adjustments, and then press ENTER to confirm. Press the MENU button for one second to exit.

RGobo Offset - Home setting adjustment for the rotating gobo.

1. Press the ENTER button for at least 3 seconds, then press the UP or DOWN buttons so that “**RGobo Offset**” is displayed, press ENTER.
2. Use the UP and DOWN buttons to make your adjustments, and then press ENTER to confirm. Press the MENU button for one second to exit.

Prism Offset - Home setting adjustment for the prism.

1. Press the ENTER button for at least 3 seconds, then press the UP or DOWN buttons so that “**Prism Offset**” is displayed, press ENTER.
2. Use the UP and DOWN buttons to make your adjustments, and then press ENTER to confirm. Press the MENU button for one second to exit.

RPrism Offset - Home setting adjustment for the rotating prism.

1. Press the ENTER button for at least 3 seconds, then press the UP or DOWN buttons so that “**RPrism Offset**” is displayed, press ENTER.
2. Use the UP and DOWN buttons to make your adjustments, and then press ENTER to confirm. Press the MENU button for one second to exit.

Focus Offset - Home setting adjustment for the focus.

1. Press the ENTER button for at least 3 seconds, then press the UP or DOWN buttons so that “**focus**” is displayed, press ENTER.
2. Use the UP and DOWN buttons to make your adjustments, and then press ENTER to confirm. Press the MENU button for one second to exit.

Iris Offset - Home setting adjustment for the iris.

1. Press the ENTER button for at least 3 seconds, then press the UP or DOWN buttons so that “**iris**” is displayed, press ENTER.
2. Use the UP and DOWN buttons to make your adjustments, and then press ENTER to confirm. Press the MENU button for one second to exit.

Master-Slave Operation This function will allow you to link up to 16 units together and operate without a controller. The units will be sound activated. In Master-Slave operation one unit will act as the controlling unit and the others will react to the controlling units programs. Any unit can act as a Master or as a Slave.

1. Using approved DMX data cables, daisy chain your units together via the XLR connector on the rear of the units. Remember the Male XLR connector is the input and the Female XLR connector is the output. The first unit in the chain (master) will use the female XLR connector only - The last unit in the chain will use the male XLR connector only. For longer cable runs we suggest a terminator at the last fixture.
2. On the Master unit find your desired show and set that show by pressing the ENTER button.
3. On the slave units tap the MENU button until “**Slave Mode**” is displayed, and Press ENTER. Choose either “**Slave 1**” or “**Slave 2**” and press ENTER. See pages 11-12 for more info.
4. The slave units will now follow the Master unit.

Universal DMX Control: This function allows you to use a Elation® universal DMX controller to control the chases and patterns, dimmer and strobe. A DMX controller allows you to create unique programs tailored to your individual needs.

1. The Inno Spot Elite is a 15 channel DMX fixture. See pages 21-23 for detailed description of the DMX values and traits.
2. To control your fixture in DMX mode, follow the set-up procedures on pages 5-7 as well as the set-up specifications that are included with your DMX controller.
3. Use the controller’s faders to control the various DMX fixture traits.
4. This will allow you to create your own programs.
5. Follow the instructions on page 12 to set the DMX address.
6. For longer cable runs (more than a 100 feet) use a terminator on the last fixture.
7. For help operating in DMX mode consult the manual included with your DMX controller.

Sound Active Mode: This mode allows either single unit or several units linked together, to run to the beat of the music.

1. Press the MENU button until “**Sound State**” is displayed, and

Inno Spot Elite

Operation

press ENTER. Tap the UP or DOWN buttons so that “ON” is displayed and press ENTER.

- You are able to adjust the sound sensitivity by pressing the MENU button until “**Sound Sense**” is displayed, and press ENTER. A number between 0-100 will be displayed. Use the UP and DOWN buttons to adjust the sensitivity to your desired, press ENTER when finished.
- The optional *UC3 Controller* (not included) may be used to control different functions including blackout.

Show Mode: This mode allows either a single unit or several units linked together, to run one of four shows that you choose.

- Press the MENU button until “**Show Mode**” is displayed, and press ENTER.
- Press the UP or DOWN buttons until you find your desired show, and press ENTER.
- The optional *UC3 Controller* (not included) may be used to control different functions including blackout.

Inno Spot Elite

UC3 Control

The optional *UC3 Controller* (not included) may be used to control different functions including blackout.

Stand By	Blackout the unit			
Function	1. Sync. Strobe	Show 1-4	1. Press to select color	1. Hold to change Master Pan position
	2. Async strobe		2. Hold to select gobo	2. Hold to change Master Tilt position
	3. Sound Strobe			3. Hold to change Master Dimmer
				4. Hold to change Slave Pan position
				5. Hold to change Slave Tilt position
				6. Hold to change Slave Dimmer
Mode	Sound (LED OFF)	Show (LED Slow Blinking)	LED ON	Position and Dimmer (LED Fast Blinking)

Inno Spot Elite

DMX Traits

Channel	Value	Function
1	0 - 255	PAN
2	0 - 255	PAN FINE
3	0 - 255	TILT
4	0 - 255	TILT FINE
5	0 - 7 8 - 15 16 - 23 24 - 31 32 - 39 40 - 47 48 - 55 56 - 63 64 - 127 128 - 189 190 - 193 194 - 255	COLORS WHITE RED ORANGE YELLOW GREEN BLUE PURPLE LIGHT BLUE COLOR MIXING CLOCKWISE ROTATION FAST - SLOW STOP COUNTER CLOCKWISE ROTATION SLOW - FAST
6	0 - 7 8 - 15 16 - 23 24 - 31 32 - 39 40 - 47 48 - 55 56 - 63 64 - 73 74 - 82 83 - 91 92 - 100 101 - 109 110 - 118 119 - 127 128 - 189 190 - 193 194 - 255	GOBO WHEEL SPOT GOBO 1 GOBO 2 GOBO 3 GOBO 4 GOBO 5 GOBO 6 GOBO 7 GOBO 1 SHAKE GOBO 2 SHAKE GOBO 3 SHAKE GOBO 4 SHAKE GOBO 5 SHAKE GOBO 6 SHAKE GOBO 7 SHAKE GOBO WHEEL ROTATION FAST - SLOW STOP GOBO WHEEL ROTATION SLOW - FAST

Inno Spot Elite		DMX Traits
Channel	Value	Function
7	0 - 127	GOBO ROTATION COUNTER-CLOCKWISE INDEX 0°-360°
	128 - 189	COUNTER-CLOCKWISE FAST - SLOW
	190 - 193	STOP
	194 - 255	CLOCKWISE SLOW - FAST
8	0 - 7	PRISM NO EFFECT
	8 - 255	PRISM EFFECT
9	0 - 127	PRISM ROTATION COUNTER-CLOCKWISE INDEX 0°-360°
	128 - 189	COUNTER-CLOCKWISE FAST - SLOW
	190 - 193	STOP
	194 - 255	CLOCKWISE SLOW - FAST
10	0 - 255	FOCUS WIDE - NARROW
		IRIS MAX. DIAMETER - MIN. DIAMETER PULSE CLOSE FAST - SLOW PULSE OPEN SLOW - FAST
12	0 - 7	SHUTTER/STROBE BLACKOUT
	8 - 15	SHUTTER OPEN
	16 - 131	STROBING SLOW - FAST
	132 - 139	SHUTTER OPEN
	140 - 181	SHUTTER SLOW OPEN - FAST CLOSE
	182 - 189	SHUTTER OPEN
	190 - 231	SHUTTER SLOW CLOSE - FAST OPEN
	232 - 239	SHUTTER OPEN
	240 - 247	RANDOM STROBE
	248 - 255	SHUTTER OPEN
13	0 - 255	DIMMER 0% - 100%
14	0 - 255	MOVEMENT SPEED FAST - SLOW
15	0 - 69	BLACKOUT/RESET NOTHING
	70 - 79	BLACKOUT W/ PAN/TILT MOVEMENT
	80 - 89	NO BLACKOUT PAN TILT MOVEMENT
	90 - 99	BLACKOUT W/ COLOR CHANGE

Inno Spot Elite		DMX Traits
Channel	Value	Function
15	100 - 109	BLACKOUT/RESET NO BLACKOUT W/ COLOR CHANGE
	110 - 119	BLACKOUT W/ GOBO CHANGE
	120 - 129	NO BLACKOUT W/ GOBO CHANGE
	130 - 199	NOTHING
	200 - 209	RESET ALL
	210 - 255	NOTHING

Inno Spot Elite Photometric Chart

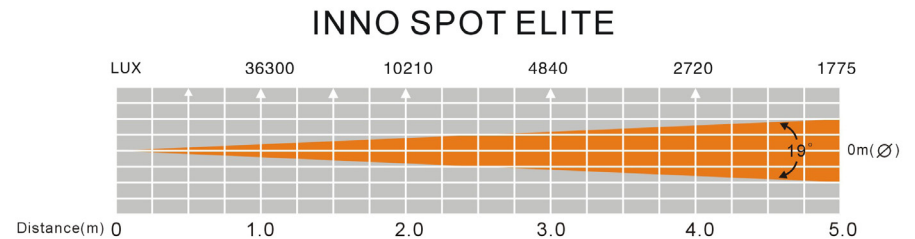

Inno Spot Elite

Gobo Replacement

This unit comes with interchangeable gobos. When changing the gobos please be very careful.

Caution! *Never open the unit when in use. Always disconnect the main power before attempting to change the gobos.*

1. To change the gobo, remove the gobo access door.
2. When you remove the gobo access door you will see the gobo wheel. Turn the gobo wheel with your hand until you find the gobo you would like to change.
3. Using a pair of needle nose pliers, grab the fixture ring that holds the gobo in place and remove the ring.
4. Once the ring is removed, carefully push the gobo out so that it falls into your hand.
5. Carefully insert your new gobo and insert the fixture ring.
6. Reassemble the unit.

Inno Spot Elite

Fuse Replacement

The fuse holder is located next to the power cord. Using a phillips screwdriver, unscrew and remove the fuse holder. Remove the bad fuse and replace with a new one.

Inno Spot Elite

Cleaning

Due to fog residue, smoke, and dust cleaning the internal and external optical lenses and mirror should be carried out periodically to optimize light output. Cleaning frequency depends on the environment in which the fixture operates (i.e. smoke, fog residue, dust, dew). In heavy club use we recommend cleaning on a monthly basis. Periodic cleaning will ensure longevity, and crisp output.

1. Use normal glass cleaner and a soft cloth to wipe down the outside casing.
2. Use a brush to wipe down the cooling vents and fan grill.
3. Clean the external optics with glass cleaner and a soft cloth every 20 days.
4. Clean the internal optics with glass cleaner and a soft cloth every 30-60 days.
5. Always be sure to dry all parts completely before plugging the unit back in.

Inno Spot Elite

Trouble Shooting

Trouble Shooting: Listed below are a few common problems that you may encounter, with solutions.

No light output from the unit;

1. Be sure the external fuse has not blown. The fuse is located on the rear panel of the unit.
2. Be sure the fuse holder is completely and properly seated.

Unit does not respond to sound;

1. Low frequencies (bass) should cause the unit to react to sound. Tapping on the microphone, quiet or high pitched sounds may not activate the unit.

Inno Spot Elite

Warranty

MANUFACTURER'S LIMITED WARRANTY

- A. ADJ Products, LLC hereby warrants, to the original purchaser, ADJ Products, LLC products to be free of manufacturing defects in material and workmanship for a prescribed period from the date of purchase (see specific warranty period on reverse). This warranty shall be valid only if the product is purchased within the United States of America, including possessions and territories. It is the owner's responsibility to establish the date and place of purchase by acceptable evidence, at the time service is sought.
- B. **For warranty service you must obtain a Return Authorization number (RA#) before sending back the product—please contact ADJ Products, LLC Service Department at 800-322-6337.** Send the product only to the ADJ Products, LLC factory. All shipping charges must be pre-paid. If the requested repairs or service (including parts replacement) are within the terms of this warranty, ADJ Products, LLC will pay return shipping charges only to a designated point within the United States. If the entire instrument is sent, it must be shipped in its original package. No accessories should be shipped with the product. If any accessories are shipped with the product, ADJ Products, LLC shall have no liability whatsoever for loss of or damage to any such accessories, nor for the safe return thereof.
- C. This warranty is void if the serial number has been altered or removed; if the product is modified in any manner which ADJ Products, LLC concludes, after inspection, affects the reliability of the product; if the product has been repaired or serviced by anyone other than the ADJ Products, LLC factory unless prior written authorization was issued to purchaser by ADJ Products, LLC; if the product is damaged because not properly maintained as set forth in the instruction manual.
- D. This is not a service contract, and this warranty does not include maintenance, cleaning or periodic check up. During the period specified above, ADJ Products, LLC will replace defective parts at its expense with new or refurbished parts, and will absorb all expenses for warranty service and repair labor by reason of defects in material or workmanship. The sole responsibility of ADJ Products, LLC under this warranty shall be limited to the repair of the product, or replacement thereof, including parts, at the sole discretion of ADJ Products, LLC. All products covered by this warranty were manufactured after August 15, 2012, and bear indentifying marks to that effect.
- E. ADJ Products, LLC reserves the right to make changes in design and/or improvements upon its products without any obligation to include these changes in any products theretofore manufactured.

No warranty, whether expressed or implied, is given or made with respect to any accessory supplied with products described above. Except to the extent prohibited by applicable law, all implied warranties made by ADJ Products, LLC in connection with this product, including warranties of merchantability or fitness, are limited in duration to the warranty period set forth above. And no warranties, whether expressed or implied, including warranties of merchantability or fitness, shall apply to this product after said period has expired. The consumer's and/or Dealer's sole remedy shall be such repair or replacement as is expressly provided above; and under no circumstances shall ADJ Products, LLC be liable for any loss or damage, direct or consequential, arising out of the use of, or inability to use, this product.

This warranty is the only written warranty applicable to ADJ Products, LLC Products and supersedes all prior warranties and written descriptions of warranty terms and conditions heretofore published.

MANUFACTURER'S LIMITED WARRANTY PERIODS:

- **Lighting Products = 1-year (365 days) Limited Warranty** (Such as: Special Effect Lighting, Intelligent Lighting, UV lighting, Strobes, Fog Machines, Bubble Machines, Mirror Balls, Par Cans, Trussing, Lighting Stands etc. excluding LED and lamps)
- **Laser Products = 90-Day Limited Warranty**
- **L.E.D. Products = 3-year (1095 days) Limited Warranty** (excluding motors, PCB boards, and power supplies, which have a 1-year (365 day Limited Warranty) and batteries which have a 180 day limited warranty). Only the L.E.D.s carry a 3-year warranty

ADJ Products, LLC - www.adj.com - Inno Spot Elite Instruction Manual Page 26

Inno Spot Elite

Specifications

Model:	Inno Spot Elite
Voltage:	100V~240V 50Hz/60Hz
Power Cord Daisy Chain:	4 Fixtures Max. (120V) 8 Fixtures Max. (240V)
LED:	1 x 180W White LED
Power Consumption:	197W (Full On)
Dimensions:	13.25"(L) x 13"(W) x 20.75"(H) 333mm x 328mm x 526mm
Beam Angle:	19 Degree
Weight:	29 Lbs. / 13 kgs.
Fuse:	7 Amp
Duty Cycle:	None
DMX:	15 DMX Channels
Colors:	7 + White
Gobos:	7 + Spot 27mm/0.2mm thickness (Metal) 1.1mm thickness (Glass) (22mm viewable)
Working Position:	Any Safe, Secure Position
Warranty:	3 Year (1095 days)

Auto Sensing Voltage: *This fixture contains a automatic voltage switch, which will auto sense the voltage when it is plugged into the power source.*

Please Note: *Specifications and improvements in the design of this unit and this manual are subject to change without any prior written notice.*

ADJ Products, LLC
6122 S. Eastern Ave. Los Angeles, CA 90040 USA
Tel: 323-582-2650 / Fax: 323-725-6100
Web: www.adj.com / E-mail: info@americandj.com

A.D.J. Supply Europe B.V.
Junostraat 2
6468 EW Kerkrade
Netherlands

service@adjgroup.eu / www.adj.eu

Tel: +31 45 546 85 00 / Fax: +31 45 546 85 99

Follow Us On:



facebook.com/americandj
twitter.com/americandj
youtube.com/adjlighting